

KOMATSU®

PC170LC-11

Tier 4 Final Engine

HYDRAULIC EXCAVATOR



Photos may include optional equipment.

NET HORSEPOWER

121 HP @ 2100 rpm
90 kW @ 2100 rpm

OPERATING WEIGHT

38,720–43,115 lb
17600–19598 kg

BUCKET CAPACITY

0.48–1.24 yd³
0.37–0.95 m³

PC170LC

WALK-AROUND

PC170LG-11



Photos may include optional equipment.

NET HORSEPOWER

121 HP @ 2100 rpm
90 kW @ 2100 rpm

OPERATING WEIGHT

38,720–43,115 lb
17600–19598 kg

BUCKET CAPACITY

0.48–1.24 yd³
0.37–0.95 m³



POWER, CONTROL AND MORE LIFT CAPACITY

Two Counterweight Options Expand Versatility

The standard counterweight provides powerful lift capacity while permitting transport on a 40,000lb tag trailer. An optional heavy counterweight maintains stability and lift when the machine is equipped with a quick coupler, bucket, and thumb.

Enhanced Power Mode

Enhanced engine and hydraulic pump control logic improves multi-function speed for up to 6% improved productivity.

A powerful **Komatsu SAA4D107E-3 engine** provides a net output of 90 kW **121 HP**. This engine is EPA Tier 4 Final emissions certified.

Water Cooled Variable Geometry Turbocharger helps improve durability and improves engine response under all speed and load conditions.

Temperature controlled viscous fan clutch helps improve fuel efficiency and reduce sound levels.

Komatsu Diesel Oxidation Catalyst (KDOC) reduces particulate matter using passive regeneration **over 98% of the time**.

Selective Catalytic Reduction (SCR) reduces NOx and has easy to access components.

Komatsu Auto Idle Shutdown helps reduce nonproductive engine idle time and reduces operating costs.

Komatsu's Closed-center Load Sensing System (CLSS) provides quick response and smooth operation to maximize productivity.

Six working modes are designed to match engine speed, pump output and system pressure to a wide range of applications.

Rearview monitoring system (standard)

Large LCD color monitor:

- 7" high resolution display
- Enhanced hydraulic attachment control with one way/two way flow and programmable work tool names and settings
- Rear view camera display integrated into the default monitor screen
- All machine settings and controls are easily accessible through the monitor

Aux jack and (2) 12V outlets

Equipment Management Monitoring System (EMMS) continuously monitors machine operation and vital systems to identify machine issues and assist with troubleshooting.

Wide access service doors provide easy access for ground level maintenance.



Enhanced working environment

- High back, heated, air suspension operator seat with adjustable arm rests
- Integrated ROPS cab design
- Cab meets ISO Level 1 Operator Protective Guard (OPG) top guard
- Standard pattern change valve to switch from ISO to BH control pattern
- Aux jack and (2) 12V power outlets
- Auto climate control

Komatsu designed and manufactured components

New engine and hydraulic control technology work together to improve multifunction and productivity up to 6% with similar fuel efficiency as the PC170LC-10.

Handrails (standard) provide convenient access to the upper structure.

Battery disconnect switch allows a technician to disconnect the power supply before servicing the machine.

Operator Identification System records KOMTRAX machine operation and application data for up to 100 individual ID codes.

KOMTRAX®

The KOMTRAX® telematics system is standard on Komatsu equipment with no subscription-fees throughout the life of the machine. Using the latest wireless technology, KOMTRAX® transmits valuable information such as location, utilization, and maintenance records to a PC or smartphone app. Custom machine reports are provided for identifying machine efficiency and operating trends. KOMTRAX® also provides advanced machine troubleshooting capabilities by continuously monitoring machine health.

PERFORMANCE FEATURES

KOMATSU NEW ENGINE TECHNOLOGIES

New Tier 4 Final Engine

The Komatsu SAA4D107E-3 engine is EPA Tier 4 Final emissions certified and provides exceptional performance and efficiency. Based on Komatsu proprietary technologies developed over many years, this new diesel engine reduces nitrogen oxides (NOx) by more than 80% when compared to Tier 4 interim levels. Through the in-house development and production of engines, electronics, and hydraulic components, Komatsu has achieved great advancements in technology, providing high levels of performance and efficiency in virtually all applications.

Technologies Applied to New Engine

Heavy-duty aftertreatment system

This new system combines a Komatsu Diesel Oxidation Catalyst (KDOC) and Selective Catalytic Reduction (SCR). The SCR NOx reduction system injects the correct amount of Diesel Exhaust Fluid (DEF) at the proper rate, thereby decomposing NOx into non-toxic water vapor (H₂O) and nitrogen gas (N₂).

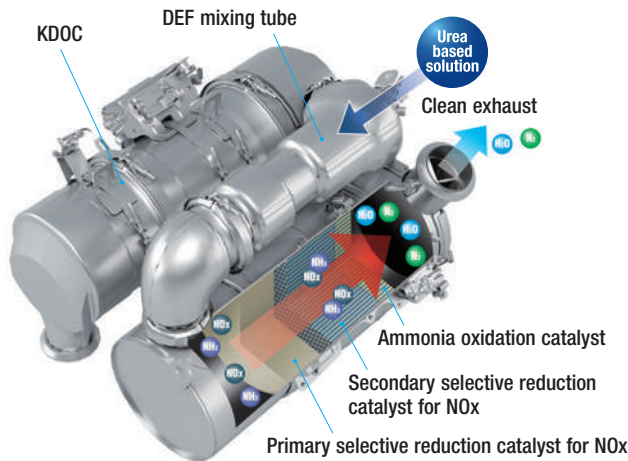

Heavy-duty cooled Exhaust Gas Recirculation (EGR) system

The system recirculates a portion of exhaust gas into the air intake and lowers combustion temperatures, thereby reducing NOx emissions. EGR gas flow has been decreased for Tier 4 Final with the addition of SCR technology. The system achieves a dynamic reduction of NOx, while helping maintain T4 interim fuel consumption levels.

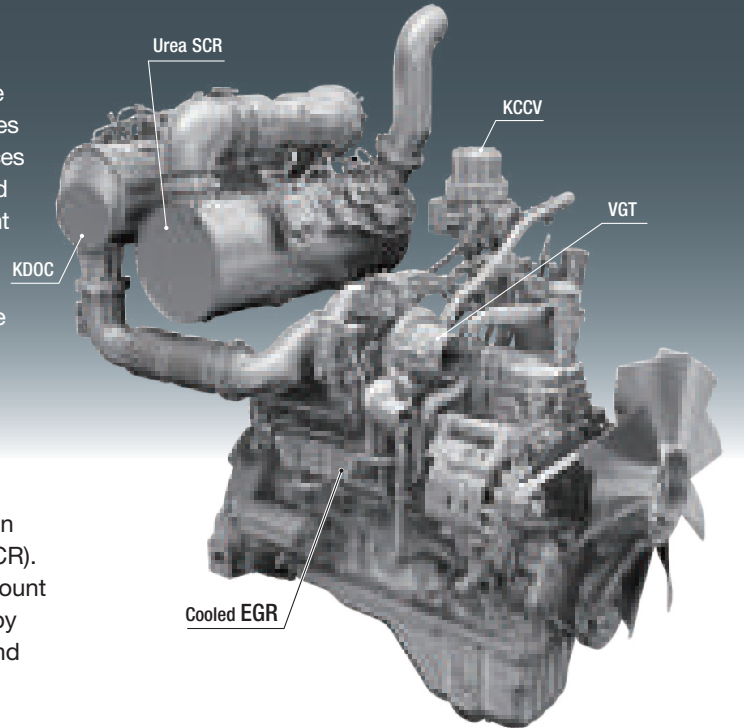
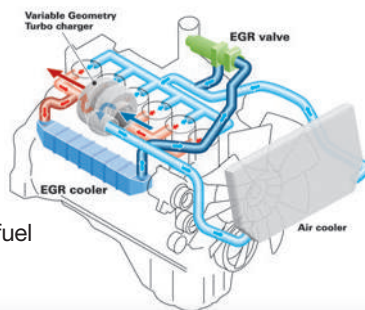

Advanced Electronic Control System

The electronic control system performs high-speed processing of all signals from sensors installed in the vehicle providing total control of equipment in all conditions of use. Engine condition information is displayed via an on-board network to the monitor inside the cab, providing necessary information to the operator. Additionally, managing the information via KOMTRAX helps customers keep up with required maintenance.

Variable Geometry Turbocharger (VGT) system

The VGT system features proven Komatsu designed hydraulic technology for variable control of air-flow and supplies optimal air according to load conditions. The upgraded version provides better exhaust temperature management.

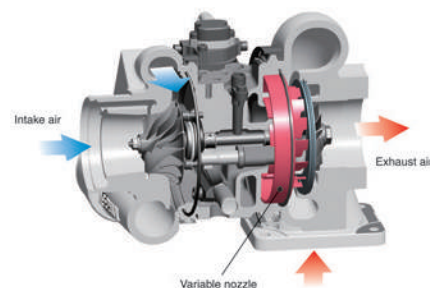

Komatsu Auto Idle Shutdown

Komatsu auto idle shutdown automatically shuts the engine down after idling for a set period of time to reduce unnecessary fuel consumption and exhaust emissions. The countdown to engine shutdown can be easily programmed from 5 to 60 minutes.



Heavy-Duty High-Pressure Common Rail (HPCR) Fuel Injection System

The system is designed to achieve an optimal injection of high-pressure fuel by means of computerized control, providing close to complete combustion to reduce PM emissions. While this technology is already used in current engines, the new system uses high pressure injection, thereby reducing PM emissions over the entire range of engine operating conditions. The Tier 4 Final engine has advanced fuel injection timing for reduced soot levels.

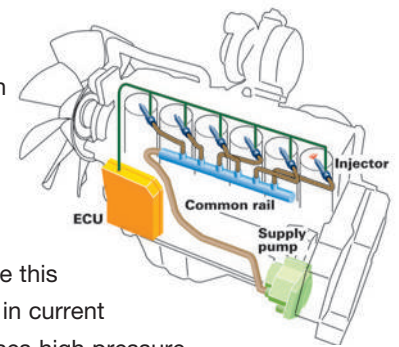

Enhanced Productivity

The PC170LC-11's enhanced P mode provides improved performance and productivity.

Productivity

Up to 6% increase
(compared to the PC170LC-10 in P Mode)

P mode (90 degree swing truck loading)



PERFORMANCE FEATURES

Increased Work Efficiency

Large digging force

With the one-touch Power Max. function digging force has been further increased. (8.5 seconds of operation)

Maximum arm crowd force (ISO)

80.4 kN(8.2t) ➔ **86.3 kN(8.8t) 7% UP**
(with Power Max.)

Maximum bucket digging force (ISO)

113 kN(11.6t) ➔ **123 kN(12.5t) 8% UP**
(with Power Max.)

Measured with Power Max. function, 2610mm arm and ISO 6015 rating.



Large Displacement High Efficiency Pump

Large displacement hydraulic implement pump provides high flow output at lower engine RPM as well as operation at the most efficient engine speed.



Working Mode Selection

The PC170LC-11 excavator is equipped with six working modes (P, E, L, B, ATT/P and ATT/E). Power Mode provides improved hydraulic power and faster cycle times for improved performance in demanding applications. Each mode is designed to match engine speed, pump flow, and system pressure to the application. The PC170LC-11 features an attachment mode (ATT/E) that allows operators to run attachments while in Economy mode.

Working Mode	Application	Advantage
P	Power Mode	•Maximum production, power & multifunction
E	Economy Mode	•Good cycle times with reduced fuel consumption
L	Lifting Mode/ Fine Control	•Increased lifting power & fine control
B	Breaker Mode	•One way flow for hydraulic breaker operation
ATT/P	Attachment Power Mode	•Two way flow with maximum power
ATT/E	Attachment Economy Mode	•Two way flow with most efficient fuel economy

- P** Performance priority
P mode
- E** Fuel savings priority
E mode
- L** Lifting operation
L mode
- B** One way flow breaker operation
B mode
- ATT/P** Two way flow attachment – Power
ATT/P mode
- ATT/E** Two way flow attachment – Economy
ATT/E mode



High Rigidity Work Equipment

Booms and arms are constructed with thick plates of high tensile strength steel. In addition, these structures are designed with large cross sectional areas and large one piece castings in the boom foot, the boom tip, and the arm tip. The result is work equipment that exhibits long term durability and high resistance to bending and torsional stress. A standard HD boom design provides increased strength and reliability.



WORKING ENVIRONMENT



WORKING ENVIRONMENT



PG170LG-11

Comfortable Working Space

Wide spacious cab

The wide spacious cab includes a heated air suspension seat with reclining backrest. The seat height and position are easily adjusted using a pull-up lever. The armrest position is easily adjusted together with the console.

Arm rest with simple height adjustment function

A knob and plunger on the armrests allows easy height adjustment without the use of tools.



Low vibration with cab damper mounting

Automatic climate control

Pressurized cab

Auxiliary input jack

Connecting a regular audio device to the auxiliary jack allows the operator to hear the sound from the stereo speakers installed in the cab.



Standard Equipment

Sliding window glass (left side)



Radio, ashtray



Remote intermittent wiper with windshield washer



Magazine box & cup holder



Opening & closing skylight



One-touch storable front window lower glass

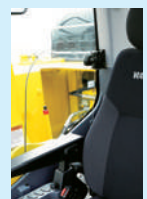

Defroster (conforms to the ISO standard)



LARGE HIGH RESOLUTION LCD MONITOR



New Monitor Panel Interface Design

An updated large high resolution LCD color monitor enables accurate and smooth work. The interface has been redesigned to display key machine information in a new user friendly interface. A rear view camera and a DEF level gauge display have been added to the default main screen. The interface has a function that enables the main screen mode to be switched, thus enabling the optimum screen information for the particular work situation to be displayed.

Indicators

- 1 Auto-decelerator
- 2 Working mode
- 3 Travel speed
- 4 Ecology gauge
- 5 Camera display
- 6 Engine coolant temperature gauge
- 7 Hydraulic oil temperature gauge
- 8 Fuel gauge
- 9 DEF level gauge
- 10 Service meter, clock
- 11 Fuel consumption gauge
- 12 Guidance icon
- 13 Function switches
- 14 Camera direction display
- 15 DEF level caution lamp

Basic operation switches

- 1 Auto-decelerator
- 2 Working mode selector
- 3 Travel speed selector
- 4 Buzzer cancel
- 5 Wiper
- 6 Window washer
- 7 Auto climate controls

Switchable Display Modes

The main screen display mode can be changed by pressing the F3 key.

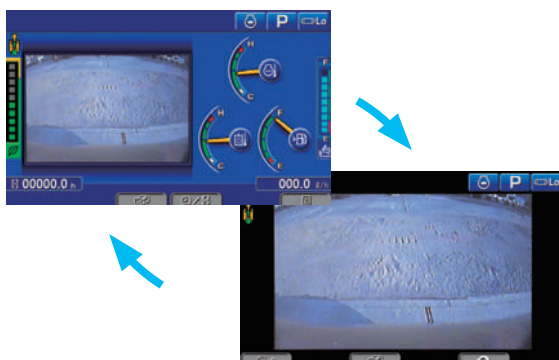

Visual user menu

Pressing the F6 key on the main screen displays the user menu screen. The menus are grouped for each function, and use easy-to-understand icons which enable the machine to be operated easily.



- 1 Energy saving guidance
- 2 Machine settings
- 3 Aftertreatment devices regeneration
- 4 SCR information
- 5 Maintenance
- 6 Monitor setting
- 7 Message check

WORKING ENVIRONMENT

Support Efficiency Improvement

Ecology guidance

While the machine is operating, ecology guidance pops up on the monitor screen to notify the operator of the status of the machine in real time.

Ecology gauge & fuel consumption gauge

The monitor screen is provided with an ecology gauge and also a fuel consumption gauge which is displayed continuously. In addition, the operator can set any desired target value of fuel consumption (within the range of the green display), enabling the machine to be operated with better fuel economy.



Ecology gauge Fuel consumption gauge
Ecology guidance

Operation record, fuel consumption history, and ecology guidance record

The ecology guidance menu enables the operator to check the operation record, fuel consumption history and ecology guidance record from the ecology guidance menu, with a single touch, thus assisting operators with reducing total fuel consumption.



Operation record

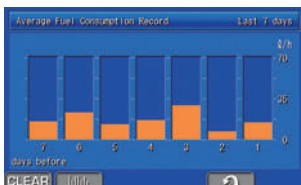

Fuel consumption history

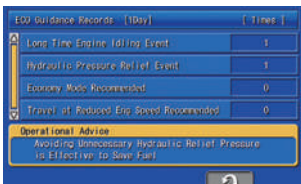

Ecology guidance record

Operator Identification Function

An operator identification (ID) code can be set for each operator and used to manage operation information of individual machines using KOMTRAX data. Data sent from KOMTRAX can be used to analyze operation status by operator, application, as well as by machine.



MAINTENANCE FEATURES

Centralized engine check points

Locations of the engine oil check and filters are integrated into one side to allow easy maintenance and service.

Engine oil filter

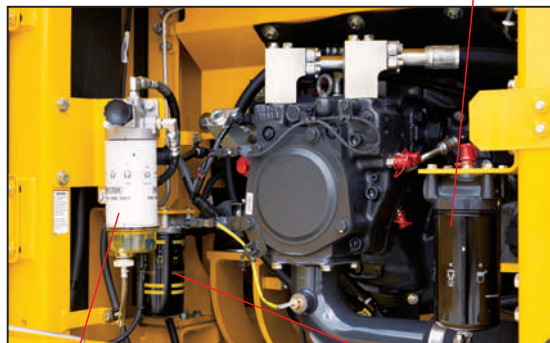

Fuel pre-filter (with water separator)

High efficiency fuel filter

Easy cleaning of coolers

Side by side panel engine and hydraulic oil coolers simplify maintenance.

Fuel pre-filter with water separator

High efficiency primary fuel filter

Easy access to engine oil filter, engine oil, drain valve, fuel drain valve and water separator drain valve

Battery disconnect switch

A standard battery disconnect switch allows a technician to disconnect the power supply and lock out before servicing the machine.



Easily accessible cabin air filter

Washable cab floor mat

Sloping track frame

Track frames are designed to allow material to escape the roller frames during travel and aid material removal during cleaning.

Utility space

A lockable utility box is located on the right-hand platform allowing for storage of items.



MAINTENANCE FEATURES

Long-life oils, filters

High performance filters are used in the hydraulic circuit and engine. By increasing the oil and filter replacement intervals, maintenance costs can be significantly reduced.



Hydraulic oil filter
(Ecology-white element)

Engine oil & Engine oil filter	every 500 hours
Hydraulic oil	every 5000 hours
Hydraulic oil filter	every 1000 hours
DEF pump filter	every 2000 hours

Large capacity air cleaner

Large capacity air cleaner is comparable to that of larger machines. The larger air cleaner can extend air cleaner life during long-term operation and helps prevent early clogging, and resulting power loss. A radial seal design is used for reliability.

Diesel Exhaust Fluid (DEF) tank

A large tank volume extends operating time before refilling and is installed on the right front platform for easy access. DEF tank and pump are separated for improved service access.

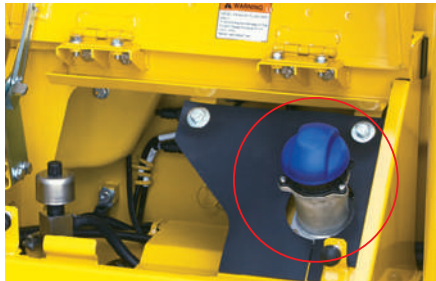

Maintenance Information

"Maintenance time caution lamp" display

When the remaining time to maintenance becomes less than 30 hours*, a maintenance time monitor appears. Pressing the F6 key switches the monitor to the maintenance screen.

* : The setting can be changed within the range between 10 and 200 hours.



Maintenance screen

Supports the DEF level and refill timing

The DEF level gauge is displayed continuously on the right side of the monitor screen. In addition, when DEF level is low, DEF low level guidance messages appear in pop up displays to inform the operator in real time.



DEF level gauge



DEF low level guidance

Cooling Package Debris Screens

Debris screens reduce cooling package core plugging and are easily removable for cleaning.



Debris Screen

DT-type connectors

Sealed DT-type electrical connectors provide high reliability, water and dust resistance.

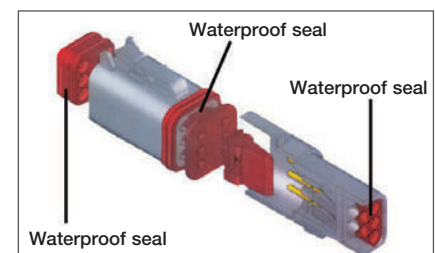

GENERAL FEATURES

ROPS CAB STRUCTURE

ROPS Cab (ISO 12117-2)

The machine is equipped with a ROPS cab that conforms to ISO 12117-2 for excavators as standard equipment. It also satisfies the requirements for Level 1 Operator Protective Guard (OPG) and top guard (ISO 10262).



Rear View Monitoring System

A new rear view monitoring system display has a rear view camera image that is continuously displayed together with the gauges and important vehicle information. This enables the operator to carry out work while easily checking the surrounding area.

Rear view camera



Rear view image on monitor



Low Vibration with Viscous Cab Mounts

The PC170LC-11 uses viscous mounts for the cab that incorporate a longer stroke and the addition of a spring. The cab damper mounting combined with a high rigidity deck reduces vibration at the operator's seat.

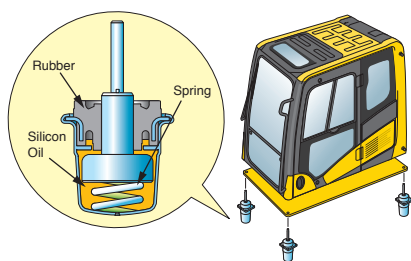

General Features

Secondary engine shut down switch at base of seat to shutdown the engine.



Lock lever

Seat belt retractable

Tempered & tinted glass

Large mirrors

Slip-resistant plates

Thermal and fan guards

Pump/engine room partition

Travel alarm

Large cab entrance step

Left and right side handrails



Seat belt caution indicator

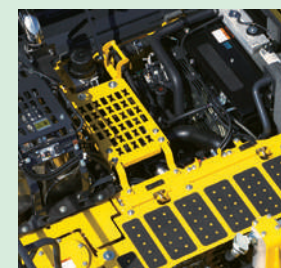

KOMATSU PARTS & SERVICE SUPPORT



KOMATSU CARE

Program Includes:

*The PC170LC-11 comes standard with complimentary factory scheduled maintenance for the first 3 Years or 2,000 Hours, whichever occurs first.

Planned Maintenance Intervals at:

500/1000/1500/2000 hour intervals. (250 hr. initial interval for some products) Complimentary Maintenance Interval includes: Replacement of Oils & Fluid Filters with genuine Komatsu Parts, 50-Point inspection, Komatsu Oil & Wear Analysis Sampling (KOWA) / Travel & Mileage (distance set by distributor; additional charges may apply)

Benefits of Using Komatsu CARE

- Assurance of Proper Maintenance with OEM Parts & Service
- Increased Uptime & Efficiency
- Factory Certified Technicians Performing Work
- Cost of Ownership Savings
- Transferable Upon Resale

Complimentary SCR System Maintenance

The PC170LC-11 also includes 2 factory recommended services of the Selective Catalytic Reduction (SCR) Diesel Exhaust Fluid (DEF) system during the first 5 years or 9,000 hours whichever occurs first. The service includes factory recommended DEF tank flush & strainer cleaning at the suggested service intervals of 4,500 hours & 9,000 hours.

KOMATSU CARE PC170LC-11

Interval PM	500	1000	1500	2000
KOWA SAMPLING – (Engine, Hydraulics, Swing Circle, L & R Final Drives)	✓	✓	✓	✓
LUBRICATE MACHINE	✓	✓	✓	✓
LUBRICATE SWING CIRCLE	✓	✓	✓	✓
CHECK SWING PINION GREASE LEVEL AND ADD, WHEN NECESSARY	✓	✓	✓	✓
CHANGE ENGINE OIL	✓	✓	✓	✓
REPLACE ENGINE OIL FILTER	✓	✓	✓	✓
REPLACE FUEL PRE-FILTER	✓	✓	✓	✓
REPLACE AC FRESH & RECIRC AIR FILTERS	✓	✓	✓	✓
CLEAN AIR CLEANER ELEMENT	✓	✓	✓	✓
DRAIN SEDIMENT FROM FUEL TANK	✓	✓	✓	✓
COMPLETE 50 POINT INSPECTION FORM; LEAVE PINK COPY WITH CUSTOMER OR IN CAB	✓	✓	✓	✓
RESET MONITOR PANEL MAINTENANCE COUNTER FOR APPROPRIATE ITEMS	✓	✓	✓	✓
REPLACE MAIN FUEL FILTER		✓		✓
REPLACE DEF TANK BREATHER		✓		✓
REPLACE HYDRAULIC OIL FILTER ELEMENT		✓		✓
REPLACE HYDRAULIC TANK BREATHER ELEMENT		✓		✓
CHANGE SWING MACHINERY OIL		✓		✓
CHECK DAMPER CASE OIL LEVEL AND ADD, WHEN NECESSARY		✓		✓
CHANGE FINAL DRIVE OIL				✓
CLEAN HYDRAULIC TANK STRAINER				✓
REPLACE KCCV FILTER ELEMENT				✓
CHANGE DEF PUMP FILTER				✓
FACTORY TRAINED TECHNICIAN LABOR	✓	✓	✓	✓
2 SCR System Maintenance Services suggested at 4,500 Hrs. and 9000 Hrs.				

* Certain exclusions and limitations apply. Refer to the customer certificate for complete program details and eligibility. Komatsu® and Komatsu Care® are registered trademarks of Komatsu Ltd. Copyright 2019 Komatsu America Corp.

Komatsu CARE® – Extended Coverage

- Extended Coverage can provide peace of mind by protecting customers from unplanned expenses that effect cash flow
- Purchasing extended coverage locks-in the cost of covered parts and labor for the coverage period and helps turn these into fixed costs



Komatsu Parts Support

- 24/7/365 to fulfill your parts needs
- 9 parts Distribution Centers strategically located across the U.S. and Canada
- Distributor network of more than 300 locations across U.S. and Canada to serve you
- Online part ordering through Komatsu eParts
- Remanufactured components with same-as-new warranties at a significant cost reduction



Komatsu Oil and Wear Analysis (KOWA)

- KOWA detects fuel dilution, coolant leaks, and measures wear metals
- Proactively maintain your equipment
- Maximize availability and performance
- Can identify potential problems before they lead to major repairs
- Reduce life cycle cost by extending component life

PC170LC-11

KOMTRAX EQUIPMENT MONITORING

GET THE WHOLE STORY WITH
KOMTRAX[®]

✓ WHAT

- KOMTRAX is Komatsu's remote equipment monitoring and management system
- KOMTRAX **continuously monitors and records** machine health and operational data
- Information such as fuel consumption, utilization, and a detailed history **lowering owning and operating cost**

✓ WHO

- KOMTRAX is **standard** equipment on all Komatsu construction products

✓ WHEN

- Knowing when machines are **running or idling** can help improve fleet utilization
- Detailed movement records ensure you know when and where your equipment is moved
- Up to date records allow you to **know when maintenance is due** and help you plan for future maintenance needs

✓ WHERE

- KOMTRAX data **can be accessed virtually anywhere** through your computer, the web or your smart phone
- Automatic alerts keep fleet managers up to date on the latest machine notifications

✓ WHY

- Knowledge is power - **make informed decisions** to manage your fleet better
- Knowing your idle time and fuel consumption will help maximize your machine efficiency
- **Take control of your equipment** - any time, anywhere



KOMTRAX[®]

For construction and compact equipment.

KOMTRAX Plus[®]

For production and mining class machines.

SPECIFICATIONS



ENGINE

Model..... Komatsu SAA4D107E-3*
 Type.....Water-cooled, 4-cycle, direct injection
 Aspiration..... Variable Geometry Turbocharger (VGT),
 aftercooled, cooled EGR
 Number of cylinders..... 4
 Bore..... 107 mm **4.21"**
 Stroke.....124 mm **4.88"**
 Piston displacement..... 4.46 ltr **272 in³**
 Horsepower:
 ISO 9249 / SAE J1349 Net 90 kW **121 HP**
 Fan at maximum speed..... Net 85 kW **114 HP**
 Rated rpm 2100
 Fan drive method for radiator cooling..... Mechanical with
 viscous fan clutch
 Governor All-speed control, electronic
 *EPA Tier 4 Final emissions certified



HYDRAULICS

Type HydraMind (Hydraulic Mechanical Intelligence)
 system, closed-center system with load sensing valves and
 pressure compensated valves

Main pump:

Type.....Variable capacity piston type
 Pumps for..... Boom, arm, bucket, swing, and travel circuits
 Maximum flow 298 ltr/min **78.7 gal/min**

Hydraulic motors:

Travel..... 2 x piston motors with parking brake
 Swing 1 x axial piston motor with swing holding brake

Relief valve setting:

Implement circuits 37.3 MPa 380 kg/cm² **5,400 psi**
 Travel Circuit..... 37.3 MPa 380 kg/cm² **5,400 psi**
 Swing circuit..... 28.9 MPa 295 kg/cm² **4,195 psi**
 Pilot circuit..... 3.2 MPa 33 kg/cm² **470 psi**

Hydraulic cylinders:

(Number of cylinders – bore x stroke x rod diameter)

Boom .. 2–110 mm x 1175 mm x 75 mm **4.3" x 46.3" x 3.0"**
 Arm1–120 mm x 1342 mm x 85 mm **4.7" x 52.8" x 3.3"**
 Bucket.. 1–105 mm x 1027 mm x 70 mm **4.1" x 40.4" x 2.8"**



DRIVES AND BRAKES

Steering control.....Two levers with pedals
 Drive method Fully hydrostatic
 Maximum drawbar pull 156 kN 15950 kgf **35,164 lbf**
 Gradeability..... 70%, 35°
 Maximum travel speed: High..... 5.5 km/h **3.4 mph**
 Low 3.0 km/h **1.9 mph**
 Service brake..... Hydraulic lock
 Parking brake.....Mechanical disc



SWING SYSTEM

Drive method Hydraulic motor
 Swing reduction..... Planetary gear
 Swing circle lubrication Grease-bathed
 Swing lock Mechanical disc brake
 Swing speed..... 12.0 rpm
 Swing torque..... 4331 kg•m **31,314 ft lbs**



UNDERCARRIAGE

Center frame X-frame leg
 Track frame.....Box-section
 Track type..... Sealed
 Track adjusterHydraulic
 Number of shoes (each side) 44
 Number of carrier rollers (each side) 2
 Number of track rollers (each side) 7



COOLANT & LUBRICANT CAPACITY (REFILLING)

Fuel tank 300 ltr **79.25 U.S. gal**
 Radiator 27.3 ltr **7.21 U.S. gal**
 Engine..... 18 ltr **4.8 U.S. gal**
 Final drive, each side.....5.4 ltr **1.43 U.S. gal**
 Swing drive4.5 ltr **1.2 U.S. gal**
 Hydraulic tank..... 121 ltr **32.0 U.S. gal**
 DEF tank 29.6 ltr **7.81 U.S. gal**



SOUND PERFORMANCE

Exterior – ISO 6395..... 99 dB(A)
 Operator – ISO 6396..... 68 dB(A)



OPERATING WEIGHT (APPROXIMATE)

Operating weight includes 5150 mm **16'11"** one-piece boom, 2610 mm **8'7"** arm,
 SAE heaped 0.95 m³ **1.24 yd³** bucket, rated capacity of lubricants, coolant, full
 fuel tank, operator, and standard equipment.

Triple-Grouser	Standard Counterweight		Heavy Counterweight	
	Operating Weight	Ground Pressure ISO 16754	Operating Weight	Ground Pressure ISO 16754
600 mm 24"	18508 kg 40,717 lb	43.86 kPa 0.45 kg/cm ² 6.36 psi	19098 kg 42,015 lb	45.26 kPa 0.46 kg/cm ² 6.56 psi
700 mm 28"	18708 kg 41,157 lb	38.0 kPa 0.39 kg/cm ² 5.51 psi	19298 kg 42,455 lb	39.2 kPa 0.4 kg/cm ² 5.69 psi
800 mm 31.5"	18908 kg 41,597 lb	33.61 kPa 0.34 kg/cm ² 4.87 psi	19498 kg 42,895 lb	34.66 kPa 0.35 kg/cm ² 5.03 psi

Component Weights

Arm including bucket cylinder and linkage

2610 mm **8'7"** arm assembly 824 kg **1817 lb**
 2610 mm **8'7"** arm assembly w/piping 878 kg **1936 lb**
 2900 mm **9'6"** arm assembly..... 907 kg **2000 lb**
 2900 mm **9'6"** arm assembly w/piping..... 963 kg **2123 lb**

One piece boom including arm cylinder

5150 mm **16'11"** boom assembly 1256 kg **2769 lb**
 5150 mm **16'11"** boom assembly w/piping..... 1256 kg **2899 lb**
 Boom cylinders x 2 127 kg **280 lb**
 Counterweight (standard) 2750 kg **6,063 lb**
 Counterweight (heavy) 3240 kg **7,143 lb**
 0.95 m³ **1.24 yd³** bucket - 42" width 705 kg **1,554 lb**



DIMENSIONS

	Arm Length	2620 mm	8'7"	2900 mm	9'6"
A	Overall length	8690 mm	28'6"	8690 mm	28'6"
B	Length on ground (transport)	4760 mm	15'7"	4565 mm	15'0"
C	Overall height (to top of boom)*	3040 mm	9'11"	3140 mm	10'4"
D	Overall width	2590 mm	8'6"		
E	Overall height (to top of cab)*	3020 mm	9'11"		
F	Overall height (to top of handrail)	3110 mm	10'2"		
G	Ground clearance, counterweight	1055 mm	3'6"		
H	Ground clearance, minimum	440 mm	1'5"		
I	Tail swing radius	2545 mm	8'4"		
J	Track length on ground	3170 mm	10'5"		
K	Track length	3965 mm	13'0"		
L	Track gauge	1990 mm	6'6"		
M	Width of crawler (600 mm Shoe)	2590 mm	8'6"		
	(700 mm Shoe)	2690 mm	8'10"		
	(800 mm Shoe)	2790 mm	9'2"		
O	Grouser height	26 mm	0'1"		
P	Machine height to top of engine cover	2710 mm	8'10"		
Q	Machine upper width	2590 mm	8'6"		
R	Distance, swing center to rear end	2515 mm	8'3"		

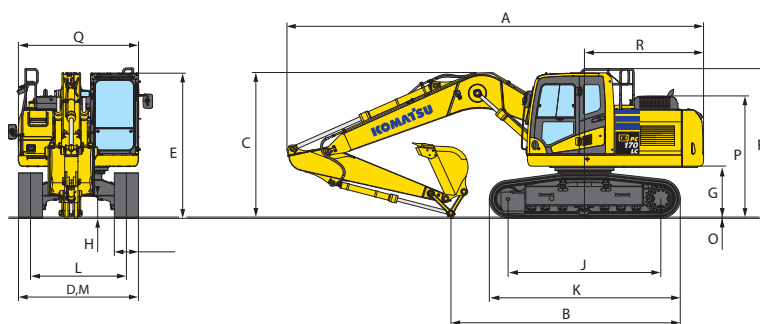
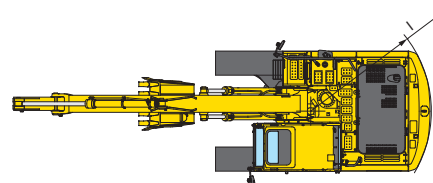

* : Including grouser height



BACKHOE BUCKET, ARM AND BOOM COMBINATION

Bucket Type	Bucket						Arms	
	Capacity		Width		Weight		2.6 m (8'7")	2.9 m (9'6")
Komatsu TL	0.47 m ³	0.61 yd ³	610 mm	24"	506 kg	1,116 lb	V	V
	0.62 m ³	0.81 yd ³	762 mm	30"	568 kg	1,252 lb	V	V
	0.78 m ³	1.02 yd ³	914 mm	36"	660 kg	1,454 lb	W	X
	0.95 m ³	1.24 yd ³	1067 mm	42"	705 kg	1,554 lb	X	Y
Komatsu HP	0.37 m ³	0.48 yd ³	508 mm	20"	511 kg	1,126 lb	V	V
	0.47 m ³	0.61 yd ³	610 mm	24"	572 kg	1,260 lb	V	V
	0.62 m ³	0.81 yd ³	762 mm	30"	649 kg	1,431 lb	V	V
	0.78 m ³	1.02 yd ³	914 mm	36"	735 kg	1,620 lb	W	X
	0.95 m ³	1.24 yd ³	1067 mm	42"	806 kg	1,776 lb	Y	Y
Komatsu HPS	0.37 m ³	0.48 yd ³	508 mm	20"	563 kg	1,241 lb	V	V
	0.47 m ³	0.61 yd ³	610 mm	24"	635 kg	1,400 lb	V	V
	0.62 m ³	0.81 yd ³	762 mm	30"	729 kg	1,607 lb	V	W
	0.78 m ³	1.02 yd ³	914 mm	36"	831 kg	1,833 lb	X	X
	0.95 m ³	1.24 yd ³	1067 mm	42"	919 kg	2,027 lb	Y	Z

V - Used with material weights up to 3,500 lb/yd³

W - Used with material weights up to 3,000 lb/yd³

X - Used with material weights up to 2,500 lb/yd³

Y - Used with material weights up to 2,000 lb/yd³

Z - Not useable

COMMENTS: When using any quick coupler or other attachment equipment, there is an increased risk of the bucket hitting the cab.

*See the Operation & Maintenance Manual for detailed bucket installation instructions.

SPECIFICATIONS



WORKING RANGE

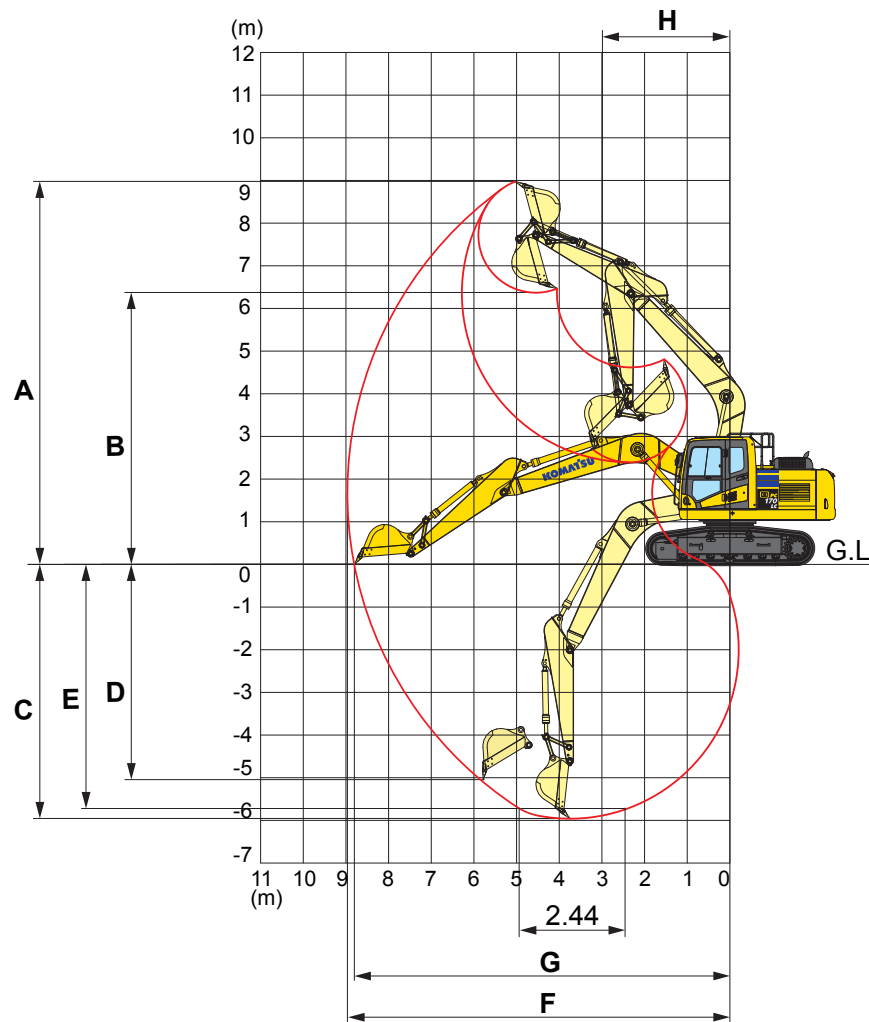

	Arm Length	2610 mm	8'7"	2900 mm	9'6"
A	Max. digging height	8980 mm	29'6"	9130 mm	29'11"
B	Max. dumping height	6370 mm	20'11"	6525 mm	21'5"
C	Max. digging depth	5960 mm	19'7"	6250 mm	20'6"
D	Max. vertical wall digging depth	5040 mm	16'6"	5320 mm	17'5"
E	Max. digging depth of cut for 8' level bottom	5740 mm	18'10"	6050 mm	19'10"
F	Max. digging reach	8960 mm	29'5"	9235 mm	30'4"
G	Max. digging reach at ground level	8800 mm	28'10"	9075 mm	29'9"
H	Min. swing radius	2990 mm	9'10"	2995 mm	9'10"
SAE rating	Bucket digging force at power max.	109 kN		109 kN	
		11100 kg / 24,504 lb		11100 kg / 24,504 lb	
	Arm crowd force at power max.	83.4 kN		77.5 kN	
		8500 kgf / 18,749 lb		7900 kgf / 17,422 lb	
ISO rating	Bucket digging force at power max.	123 kN		123 kN	
		12500 kg / 27,651 lb		12500 kg / 27,651 lb	
	Arm crowd force at power max.	86.3 kN		79.4 kN	
		8800 kgf / 19,401 lb		8100 kgf / 17,849 lb	

LIFT CAPACITIES



LIFTING CAPACITY WITH LIFTING MODE

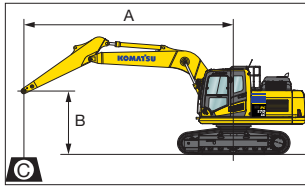

- A: Reach from swing center
- B: Bucket hook height
- C: Lifting capacity
- Cf: Rating over front
- Cs: Rating over side
- ⊗: Rating at maximum reach

- Conditions:
- 5150 mm **16' 11"** one-piece boom
 - Counterweight: 2750 kg **6,063 lb**
 - Bucket: None

Arm: 2610 mm 8'7" Shoes: 600 mm 24" triple grouser Bucket: None Unit: kg lb

B	A		1.5 m 5'		3.0 m 10'		4.6 m 15'		6.1 m 20'		7.6 m 25'		⊗ MAX		
	Cf	Cs	Cf	Cs	Cf	Cs	Cf	Cs	Cf	Cs	Cf	Cs	⊗	Cf	Cs
7.6 m													4.7	* 3400	* 3400
25'													15.4	* 7490	* 7490
6.1 m									* 3350	* 3350			6.2	* 3000	* 3000
20'									* 7380	* 7380			20.3	* 6610	* 6610
4.6 m													7	* 2900	2750
15'					* 5500	5300	* 5000	3450					23.0	* 6390	6060
3.0 m													7.5	* 2950	2450
10'					* 10500	9050	* 6750	5000	5150	3350			24.6	* 6500	5400
1.5 m													7.6	* 3150	2350
5'													24.9	* 6940	5180
0 m													7.4	* 3600	2400
0'					* 7100	* 7100	7450	4500	4900	3100			24.3	* 7930	5290
-1.5 m	* 6500	* 6500	* 11250	8000	7400	4450	4850	3050					6.9	4100	2600
-5'	* 14330	* 14330	* 24800	17630	16310	9810	10690	6720					22.6	9030	5730
-3.0 m	* 10950	* 10950	* 10800	8100	7450	4500							5.9	5100	3200
-10'	* 24140	* 24140	* 23800	17850	16420	9920							19.4	11240	7050

Arm: 2900 mm 9'6" Shoes: 600 mm 24" triple grouser Bucket: None Unit: kg lb

B	A		1.5 m 5'		3.0 m 10'		4.6 m 15'		6.1 m 20'		7.6 m 25'		⊗ MAX		
	Cf	Cs	Cf	Cs	Cf	Cs	Cf	Cs	Cf	Cs	Cf	Cs	⊗	Cf	Cs
7.6 m													5.1	* 2950	* 2950
25'													16.7	* 6500	* 6500
6.1 m													6.5	* 2650	* 2650
20'									* 3800	3500			21.3	* 5840	* 5840
4.6 m													7.3	* 2550	* 2550
15'									* 4750	3450			23.9	* 5620	* 5620
3.0 m													7.8	* 2600	2300
10'					* 9200	* 9200	* 6400	5000	5150	3300	* 3300	2400	25.6	* 5730	5070
1.5 m													7.9	* 2800	2200
5'					* 7500	* 7500	7700	4700	5000	3150	3600	2300	25.9	* 6170	4850
0 m													7.7	* 3100	2250
0'					* 7450	* 7450	7400	4450	4850	3050	3550	2250	25.3	* 6830	4960
-1.5 m	* 6100	* 6100	* 10750	7850	7300	4350	4800	3000					7.2	* 3750	2450
-5'	* 13440	* 13440	* 23690	17300	16090	9590	10580	6610					23.6	* 8260	5400
-3.0 m	* 9950	* 9950	* 11250	8000	7350	4400	4850	3000					6.3	4650	2900
-10'	* 21930	* 21930	* 24800	17630	16200	9700	10690	6610					20.7	10250	6390
-4.6 m													4.7	* 5200	4400
-15'					* 8050	* 8050	* 5450	4550					15.4	* 11460	9700

Arm: 2610 mm 8'7" Shoes: 700 mm 28" triple grouser Bucket: None Unit: kg lb

B	A		1.5 m 5'		3.0 m 10'		4.6 m 15'		6.1 m 20'		7.6 m 25'		⊗ MAX		
	Cf	Cs	Cf	Cs	Cf	Cs	Cf	Cs	Cf	Cs	Cf	Cs	⊗	Cf	Cs
7.6 m													4.7	* 3400	* 3400
25'													15.4	* 7490	* 7490
6.1 m													6.2	* 3000	* 3000
20'									* 3350	3350			20.3	* 6610	* 6610
4.6 m													7	* 2900	2800
15'									* 5000	3500			23.0	* 6390	6170
3.0 m													7.5	* 2950	2500
10'					* 10050	9150	* 6750	5050	5250	3350			24.6	* 6500	5510
1.5 m													7.6	* 3150	2400
5'													24.9	* 6940	5290
0 m													7.4	* 3600	2400
0'					* 7100	* 7100	7550	4550	4950	3150			24.3	* 7930	5290
-1.5 m	* 6500	* 6500	* 11250	8100	7500	4500	4900	3100					6.9	4150	2650
-5'	* 14330	* 14330	* 24800	17850	16530	9920	10800	6830					22.6	9140	5840
-3.0 m	* 10950	* 10950	* 10800	8200	7550	4550							5.9	5150	3250
-10'	* 24140	* 24140	* 23800	18070	16640	10030							19.4	11350	7160

*Asterisk indicates load is limited by hydraulic capacity rather than tipping. Ratings are based on ISO standard No. 10567. Rated load capacity does not exceed 87% of hydraulic lift capacity or 75% of tipping load. Total weight of bucket and/or installed attachments must be deducted from the capacities shown above. Lift capacity chart is based on machine located on a solid, level and uniform surface. Load ratings are at the arm bucket pin location, use of any attachment point in a different location to handle objects could affect excavator lift performance.

LIFT CAPACITIES



LIFTING CAPACITY WITH LIFTING MODE

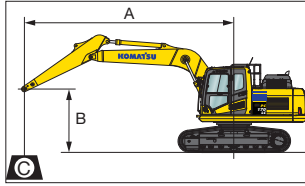

- A: Reach from swing center
- B: Bucket hook height
- C: Lifting capacity
- Cf: Rating over front
- Cs: Rating over side
- ⊗: Rating at maximum reach

Conditions:

- 5150 mm 16' 11" one-piece boom
- Counterweight: 2750 kg 6,063 lb
- Bucket: None

Arm: 2900 mm 9'6" Shoes: 700 mm 28" triple grouser Bucket: None Unit: kg lb

B	A		3.0 m 10'		4.6 m 15'		6.1 m 20'		7.6 m 25'		⊗ MAX		
	Cf	Cs	Cf	Cs	Cf	Cs	Cf	Cs	Cf	Cs	⊗	Cf	Cs
7.6 m 25'											5.1	* 2950	* 2950
											16.7	* 6500	* 6500
6.1 m 20'							* 3800	3550			6.5	* 2650	* 2650
							* 8370	7820			21.3	* 5840	* 5840
4.6 m 15'							* 4750	3500			7.3	* 2550	* 2550
							* 10470	7710			23.9	* 5620	* 5620
3.0 m 10'			* 9200	* 9200	* 6400	5050	5200	3350	* 3300	2400	7.8	* 2600	2350
			* 20280	* 20280	* 14100	11130	11460	7380	* 7270	5290	25.6	* 5730	5180
1.5 m 5'			* 7500	* 7500	* 7750	4750	5050	3200	3650	2350	7.9	* 2800	2250
			* 16530	* 16530	* 17080	10470	11130	7050	8040	5180	25.9	* 6170	4960
0 m 0'			* 7450	* 7450	7500	4500	4900	3100	3600	2300	7.7	* 3100	2250
			* 16420	* 16420	16530	9920	10800	6830	7930	5070	25.3	* 6830	4960
-1.5 m -5'	* 6100	* 6100	* 10750	7950	7400	4400	4850	3050			7.2	* 3750	2450
	* 13440	* 13440	* 23690	17520	16310	9700	10690	6720			23.6	* 8260	5400
-3.0 m -10'	* 9950	* 9950	* 11250	8050	7450	4450	4900	3050			6.3	* 4700	2950
	* 21930	* 21930	* 24800	17740	16420	9810	10800	6720			20.7	* 10360	6500
-4.6 m -15'			* 8050	* 8050	* 5450	4600					4.7	* 5200	4450
			* 17740	* 17740	* 12010	10140					15.4	* 11460	9810

Arm: 2610 mm 8'7" Shoes: 800 mm 31.5" triple grouser Bucket: None Unit: kg lb

B	A		3.0 m 10'		4.6 m 15'		6.1 m 20'		7.6 m 25'		⊗ MAX		
	Cf	Cs	Cf	Cs	Cf	Cs	Cf	Cs	Cf	Cs	⊗	Cf	Cs
7.6 m 25'											4.7	* 3400	* 3400
											15.4	* 7490	* 7490
6.1 m 20'							* 3350	* 3350			6.2	* 3000	* 3000
							* 7380	* 7380			20.3	* 6610	* 6610
4.6 m 15'					* 5500	5400	* 5000	3550			7	* 2900	2800
					* 12120	11900	* 11020	7820			23.0	* 6390	6170
3.0 m 10'			* 10050	9250	* 6750	5100	5300	3400			7.5	* 2950	2500
			* 22150	20390	* 14880	11240	11680	7490			24.6	* 6500	5510
1.5 m 5'					7900	4800	5150	3250			7.6	* 3150	2400
					17410	10580	11350	7160			24.9	* 6940	5290
0 m 0'			* 7100	* 7100	7650	4600	5000	3150			7.4	* 3600	2450
			* 15650	* 15650	16860	10140	11020	6940			24.3	* 7930	5400
-1.5 m -5'	* 6500	* 6500	* 11250	8150	7550	4550	4950	3100			6.9	* 4200	2700
	* 14330	* 14330	* 24800	17960	16640	10030	10910	6830			22.6	* 9250	5950
-3.0 m -10'	* 10950	* 10950	* 10800	8300	7600	4600					5.9	* 5250	3300
	* 24140	* 24140	* 23800	18290	16750	10140					19.4	* 11570	7270

Arm: 2900 mm 9'6" Shoes: 800 mm 31.5" triple grouser Bucket: None Unit: kg lb

B	A		3.0 m 10'		4.6 m 15'		6.1 m 20'		7.6 m 25'		⊗ MAX		
	Cf	Cs	Cf	Cs	Cf	Cs	Cf	Cs	Cf	Cs	⊗	Cf	Cs
7.6 m 25'											5.1	* 2950	* 2950
											16.7	* 6500	* 6500
6.1 m 20'							* 3800	3600			6.5	* 2650	* 2650
							* 8370	7930			21.3	* 5840	* 5840
4.6 m 15'							* 4750	3550			7.3	* 2550	* 2550
							* 10470	7820			23.9	* 5620	* 5620
3.0 m 10'			* 9200	* 9200	* 6400	5100	* 5300	3400	* 3300	2450	7.8	* 2600	2350
			* 20280	* 20280	* 14100	11240	* 11680	7490	* 7270	5400	25.6	* 5730	5180
1.5 m 5'			* 7500	* 7500	* 7750	4800	5100	3250	3700	2400	7.9	* 2800	2250
			* 16530	* 16530	* 17080	10580	11240	7160	8150	5290	25.9	* 6170	4960
0 m 0'			* 7450	* 7450	7600	4550	5000	3100	3650	2350	7.7	* 3100	2300
			* 16420	* 16420	16750	10030	11020	6830	8040	5180	25.3	* 6830	5070
-1.5 m -5'	* 8100	* 6100	* 10750	8050	7500	4450	4900	3050			7.2	* 3750	2500
	* 17850	* 13440	* 23690	17740	16530	9810	10800	6720			23.6	* 8260	5510
-3.0 m -10'	* 9950	* 9950	* 11250	8150	7550	4600	4950	3100			6.3	* 4750	3000
	* 21930	* 21930	* 24800	17960	16640	10140	10910	6830			20.7	* 10470	6610
-4.6 m -15'			* 8050	* 8050	* 5450	4650					4.7	* 5200	4500
			* 17740	* 17740	* 12010	10250					15.4	* 11460	9920

*Asterisk indicates load is limited by hydraulic capacity rather than tipping. Ratings are based on ISO standard No. 10567. Rated load capacity does not exceed 87% of hydraulic lift capacity or 75% of tipping load. Total weight of bucket and/or installed attachments must be deducted from the capacities shown above. Lift capacity chart is based on machine located on a solid, level and uniform surface. Load ratings are at the arm bucket pin location, use of any attachment point in a different location to handle objects could affect excavator lift performance.



LIFTING CAPACITY WITH LIFTING MODE

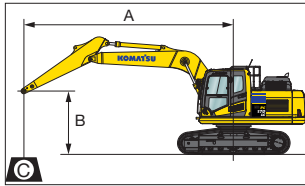

- A: Reach from swing center
- B: Bucket hook height
- C: Lifting capacity
- Cf: Rating over front
- Cs: Rating over side
- ⊗: Rating at maximum reach

- Conditions:
- 5150 mm **16' 11"** one-piece boom
 - Counterweight: 3240 kg **7,143 lb**
 - Bucket: None

Arm: 2610 mm 8'7" Shoes: 600 mm 24" triple grouser Bucket: None Unit: kg lb

B	A		1.5 m 5'		3.0 m 10'		4.6 m 15'		6.1 m 20'		7.6 m 25'		⊗ MAX		
	Cf	Cs	Cf	Cs	Cf	Cs	Cf	Cs	Cf	Cs	Cf	Cs	⊗	Cf	Cs
7.6 m													4.7	* 3400	* 3400
25'													15.4	* 7490	* 7490
6.1 m									* 3350	* 3350			6.2	* 3000	* 3000
20'									* 7380	* 7380			20.3	* 6610	* 6610
4.6 m													7.0	* 2900	* 2900
15'													23.0	* 6390	* 6390
3.0 m													7.5	* 2950	2650
10'													24.6	* 6500	5840
1.5 m													7.6	* 3150	2550
5'													24.9	* 6940	5620
0 m													7.4	* 3600	2600
0'													24.3	* 7930	5730
-1.5 m	* 6500	* 6500	* 11250	8600	7850	4800	5150	3300					6.9	* 4350	2850
-5'	* 14330	* 14330	* 24800	18950	17300	10580	11350	7270					22.6	* 9590	6280
-3.0 m	* 10950	* 10950	* 10800	8750	* 7700	4850							5.9	5450	3450
-10'	* 24140	* 24140	* 23800	19290	* 16970	10690							19.4	12010	7600

Arm: 2900 mm 9'6" Shoes: 600 mm 24" triple grouser Bucket: None Unit: kg lb

B	A		1.5 m 5'		3.0 m 10'		4.6 m 15'		6.1 m 20'		7.6 m 25'		⊗ MAX		
	Cf	Cs	Cf	Cs	Cf	Cs	Cf	Cs	Cf	Cs	Cf	Cs	⊗	Cf	Cs
7.6 m													4.7	* 3400	* 3400
25'													15.4	* 7490	* 7490
6.1 m									* 3350	* 3350			6.2	* 3000	* 3000
20'									* 7380	* 7380			20.3	* 6610	* 6610
4.6 m													7	* 2900	* 2900
15'													23.0	* 6390	* 6390
3.0 m													7.5	* 2950	2650
10'													24.6	* 6500	5840
1.5 m													7.6	* 3150	2550
5'													24.9	* 6940	5620
0 m													7.4	* 3600	2600
0'													24.3	* 7930	5730
-1.5 m	* 6500	* 6500	* 11250	8600	7850	4800	5150	3300					6.9	* 4350	2850
-5'	* 14330	* 14330	* 24800	18950	17300	10580	11350	7270					22.6	* 9590	6280
-3.0 m	* 10950	* 10950	* 10800	8750	* 7700	4850							5.9	5450	3450
-10'	* 24140	* 24140	* 23800	19290	* 16970	10690							19.4	12010	7600

*Asterisk indicates load is limited by hydraulic capacity rather than tipping. Ratings are based on ISO standard No. 10567. Rated load capacity does not exceed 87% of hydraulic lift capacity or 75% of tipping load. Total weight of bucket and/or installed attachments must be deducted from the capacities shown above. Lift capacity chart is based on machine located on a solid, level and uniform surface. Load ratings are at the arm bucket pin location, use of any attachment point in a different location to handle objects could affect excavator lift performance.

LIFT CAPACITIES



LIFTING CAPACITY WITH LIFTING MODE

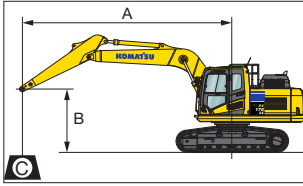

- A: Reach from swing center
- B: Bucket hook height
- C: Lifting capacity
- Cf: Rating over front
- Cs: Rating over side
- ⊗: Rating at maximum reach

Conditions:

- 5150 mm 16' 11" one-piece boom
- Counterweight: 3240 kg 7,143 lb
- Bucket: None

Arm: 2610 mm 8'7" Shoes: 700 mm 28" triple grouser Bucket: None Unit: kg lb

B	A		1.5 m 5'		3.0 m 10'		4.6 m 15'		6.1 m 20'		7.6 m 25'		⊗ MAX		
	Cf	Cs	Cf	Cs	Cf	Cs	Cf	Cs	Cf	Cs	Cf	Cs	⊗	Cf	Cs
7.6 m 25'													4.7	* 3400	* 3400
													15.4	* 7490	* 7490
6.1 m 20'									* 3350	* 3360			6.2	* 3000	* 3000
									* 7380	* 7400			20.3	* 6610	* 6610
4.6 m 15'							* 5500	* 5500	* 5000	3750			7	* 2900	* 2900
							* 12120	* 12120	* 11020	8260			23.0	* 6390	* 6390
3.0 m 10'			* 10050	9750	* 6750	5400	* 5500	3600					7.5	* 2950	2700
			* 22150	21490	* 14880	11900	* 12120	7930					24.6	* 6500	5950
1.5 m 5'					* 8050	5100	5400	3500					7.6	* 3160	2550
					* 17740	11240	11900	7710					24.9	* 6960	5620
0 m 0'			* 7100	* 7100	8050	4900	5250	3350					7.4	* 3600	2600
			* 15650	* 15650	17740	10800	11570	7380					24.3	* 7930	5730
-1.5 m -5'	* 6500	* 6500	* 11250	8700	7950	4850	5200	3350					6.9	* 4350	2850
	* 14330	* 14330	* 24800	19180	17520	10690	11460	7380					22.6	* 9590	6280
-3.0 m -10'	* 10950	* 10950	* 10800	8850	* 7700	4900							5.9	5500	3500
	* 24140	* 24140	* 23800	19510	* 16970	10800							19.4	12120	7710

Arm: 2900 mm 9'6" Shoes: 700 mm 28" triple grouser Bucket: None Unit: kg lb

B	A		1.5 m 5'		3.0 m 10'		4.6 m 15'		6.1 m 20'		7.6 m 25'		⊗ MAX		
	Cf	Cs	Cf	Cs	Cf	Cs	Cf	Cs	Cf	Cs	Cf	Cs	⊗	Cf	Cs
7.6 m 25'													5.1	* 2950	* 2950
													16.7	* 6500	* 6500
6.1 m 20'									* 3800	3800			6.5	* 2650	* 2650
									* 8370	8370			21.3	* 5840	* 5840
4.6 m 15'									* 4750	3750			7.3	* 2550	* 2550
									* 10470	8260			23.9	* 5620	* 5620
3.0 m 10'			* 9200	* 9200	* 6400	5400	* 5300	3600	* 3300	2600			7.8	* 2600	2500
			* 20280	* 20280	* 14100	11900	* 11680	7930	* 7270	5730			25.6	* 5730	5510
1.5 m 5'			* 7500	* 7500	* 7750	5100	5350	3450	3900	2550			7.9	* 2800	2400
			* 16530	* 16530	* 17080	11240	11790	7600	8590	5620			25.9	* 6170	5290
0 m 0'			* 7450	* 7450	8000	4850	5250	3350	* 3700	2500			7.7	* 3100	2450
			* 16420	* 16420	17630	10690	11570	7380	* 8150	5510			25.3	* 6830	5400
-1.5 m -5'	* 6100	* 6100	* 10750	8600	7900	4750	5150	3250					7.2	* 3750	2650
	* 13440	* 13440	* 23690	18950	17410	10470	11350	7160					23.6	* 8260	5840
-3.0 m -10'	* 9950	* 9950	* 11250	8700	* 7900	4800	6200	3300					6.3	5000	3200
	* 21930	* 21930	* 24800	19180	* 17410	10580	13660	7270					20.7	11020	7050
-4.6 m -15'			* 8050	* 8050	* 5450	4950							4.7	* 5200	4800
			* 17740	* 17740	* 12010	10910							15.4	* 11460	10580

*Asterisk indicates load is limited by hydraulic capacity rather than tipping. Ratings are based on ISO standard No. 10567. Rated load capacity does not exceed 87% of hydraulic lift capacity or 75% of tipping load. Total weight of bucket and/or installed attachments must be deducted from the capacities shown above. Lift capacity chart is based on machine located on a solid, level and uniform surface. Load ratings are at the arm bucket pin location, use of any attachment point in a different location to handle objects could affect excavator lift performance.

PG170LG-11



LIFTING CAPACITY WITH LIFTING MODE

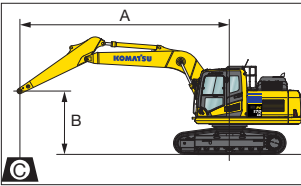

- A: Reach from swing center
- B: Bucket hook height
- C: Lifting capacity
- Cf: Rating over front
- Cs: Rating over side
- ⊗: Rating at maximum reach

- Conditions:
- 5150 mm **16' 11"** one-piece boom
 - Counterweight: 3240 kg **7,143 lb**
 - Bucket: None

Arm: 2610 mm 8'7" Shoes: 800 mm 31.5" triple grouser Bucket: None Unit: kg lb

B	A		1.5 m 5'		3.0 m 10'		4.6 m 15'		6.1 m 20'		7.6 m 25'		⊗ MAX		
	Cf	Cs	Cf	Cs	Cf	Cs	Cf	Cs	Cf	Cs	Cf	Cs	⊗	Cf	Cs
7.6 m													4.7	* 3400	* 3400
25'													15.4	* 7490	* 490
6.1 m									* 3350	* 3350			6.2	* 3000	* 3000
20'									* 7380	* 7380			20.3	* 6610	* 6610
4.6 m					* 5500	* 5500			* 6000	3750			7.0	* 2900	* 2900
15'					* 12120	* 12120			* 13220	8260			23.0	* 6390	* 6390
3.0 m			* 10050	9850	* 6750	6450			* 5500	3650			7.5	* 2950	2700
10'			* 22150	21710	* 14880	14210			* 12120	8040			24.6	* 6500	5950
1.5 m					* 8050	5150			5450	3500			7.6	* 3150	2600
5'					* 17740	11350			12010	7710			24.9	* 6940	5730
0 m			* 7100	* 7100	8100	4950			5350	3400			7.4	* 3600	2650
0'			* 15650	* 15650	17850	10910			11790	7490			24.3	* 7930	5840
-1.5 m	* 6500	* 6500	* 11250	8800	8050	4900			5300	3350			6.9	* 4350	2900
-5'	* 14330	* 14330	* 24800	19400	17740	10800			11680	7380			22.6	* 9590	6390
-3.0 m	* 10950	* 10950	* 10800	8900	* 7700	4950							5.9	5550	3550
-10'	* 24140	* 24140	* 23800	19620	* 16970	10910							19.4	12230	7820

Arm: 2900 mm 9'6" Shoes: 800 mm 31.5" triple grouser Bucket: None Unit: kg lb

B	A		1.5 m 5'		3.0 m 10'		4.6 m 15'		6.1 m 20'		7.6 m 25'		⊗ MAX		
	Cf	Cs	Cf	Cs	Cf	Cs	Cf	Cs	Cf	Cs	Cf	Cs	⊗	Cf	Cs
7.6 m													5.1	* 2950	* 2950
25'													16.7	* 6500	* 6500
6.1 m									* 3800	* 3800			6.5	* 2650	* 2650
20'									* 8370	* 8370			21.3	* 5840	* 5840
4.6 m									* 4750	3750			7.3	* 2550	* 2550
15'									* 10470	8260			23.9	* 5620	* 5620
3.0 m			* 9200	* 9200	* 6400	5450			* 5300	3650	* 3300	2650	7.8	* 2600	2550
10'			* 20280	* 20280	* 14100	12010			* 11680	8040	* 7270	5840	25.6	* 5730	5620
1.5 m			* 7500	* 7500	* 7750	5150			5400	3500	3950	2550	7.9	* 2800	2450
5'			* 16530	* 16530	* 17080	11350			11900	7710	8700	5620	25.9	* 6170	5400
0 m			* 7450	* 7450	8050	4900			5300	3350	* 3700	2500	7.7	* 3100	2500
0'			* 16420	* 16420	17740	10800			11680	7380	* 8150	5510	25.3	* 6830	5510
-1.5 m	* 6100	* 6100	* 10750	8650	7950	4800			5200	3300			7.2	* 3750	2700
-5'	* 13440	* 13440	* 23690	19060	17520	10580			11460	7270			23.6	* 8260	5950
-3.0 m	* 9950	* 9950	* 11250	8800	* 7900	4850			5250	3350			6.3	5050	3250
-10'	* 21930	* 21930	* 24800	19400	* 17410	10690			11570	7380			20.7	11130	7160
-4.6 m			* 8050	* 8050	* 5450	5000							4.7	* 5200	4850
-15'			* 17740	* 17740	* 12010	11020							15.4	* 11460	10690

*Asterisk indicates load is limited by hydraulic capacity rather than tipping. Ratings are based on ISO standard No. 10567. Rated load capacity does not exceed 87% of hydraulic lift capacity or 75% of tipping load. Total weight of bucket and/or installed attachments must be deducted from the capacities shown above. Lift capacity chart is based on machine located on a solid, level and uniform surface. Load ratings are at the arm bucket pin location, use of any attachment point in a different location to handle objects could affect excavator lift performance.



STANDARD EQUIPMENT

- Alternator, 85 Ampere, 24V
- AM/FM radio
- Automatic engine warm-up system
- Automatic climate control/air conditioner/heater/defroster
- Auxiliary input (3.5mm jack)
- Batteries, large capacity
- Battery disconnect switch
- Boom holding valve
- Converter, (2) x 12V
- Dry type air cleaner, double element
- Electric horn
- EMMS monitoring system
- Engine, Komatsu SAA4D107E-3
- Engine overheat prevention system
- Extended work equipment grease interval
- Fan guard structure
- Fuel system pre-cleaner 10 micron
- High back air suspension seat, with heat
- Hydraulic track adjusters
- KOMTRAX® Level 5
- Large LCD color monitor, high resolution
- Lock lever
- Mirrors, (LH and RH)
- Operator identification function
- Operator Protective Top Guard (OPG), Level 1 (ISO 10262)
- Pattern change valve (ISO to BH control)
- PPC hydraulic control system
- Pump/engine room partition
- Radiator and oil cooler debris screen
- Rear reflectors
- Rearview monitoring system (1 camera)
- Revolving frame undercovers
- ROPS cab (ISO 12117-2)
- Seat belt, retractable, 76mm **3"**
- Seat belt indicator
- Secondary engine shutoff switch
- Service valve
- Shoes, triple grouser, 600 mm **24"**
- Skylight
- Slip resistant foot plates
- Starter motor, 4.5kW
- Suction fan with viscous clutch
- Track frame swivel guard
- Travel alarm
- Two speed travel with auto shift
- Working lights, 1 cab LH side/1 boom RH
- Working mode selection system



OPTIONAL EQUIPMENT

- Arms
 - 2900 mm **9'6"** arm assembly
 - 2610 mm **8'7"** arm assembly
 - 2900 mm **9'6"** arm w/ one actuator piping
 - 2610 mm **8'7"** arm w/ one actuator piping
- Boom
 - 5150 mm **16'11"** boom assembly
 - 5150 mm **16'11"** boom w/ one actuator piping
- Counterweight
 - 2750 kg **6,063 lb**
 - 3240 kg **7,143 lb**
- Cab guards
 - Full front guard, OPG Level 1
 - Full front guard, OPG Level 2
 - Bolt-on top guard, OPG Level 2
- Hydraulic control unit, 1 actuator
- Shoes, triple grouser, 700 mm **28"**
- Shoes, triple grouser, 800 mm **31.5"**
- Sun visor
- Rain visor



ATTACHMENT OPTIONS

- Buckets
- Hydraulic couplers
- Hydraulic kits, field installed
- Thumbs

For a complete list of available attachments, please contact your local Komatsu distributor.

KOMATSU®

Note: All comparisons and claims of improved performance made herein are made with respect to the prior Komatsu model unless otherwise specifically stated.