



SR-45 ADVANCED

soilmec 
Drilling and Foundation Equipment

Advanced technology and flexibility.

The SR-45 has become well known for its characteristics of dynamism and drilling capabilities combined with quick and efficient mobilization for rapid start-up on job sites.

The 2021 SR-45 brand new model has been upgraded to the HD version which features the segmental mast boosting its versatility and Low Headroom operation capability, in addition to a monolithic HD mast with improved capacity.

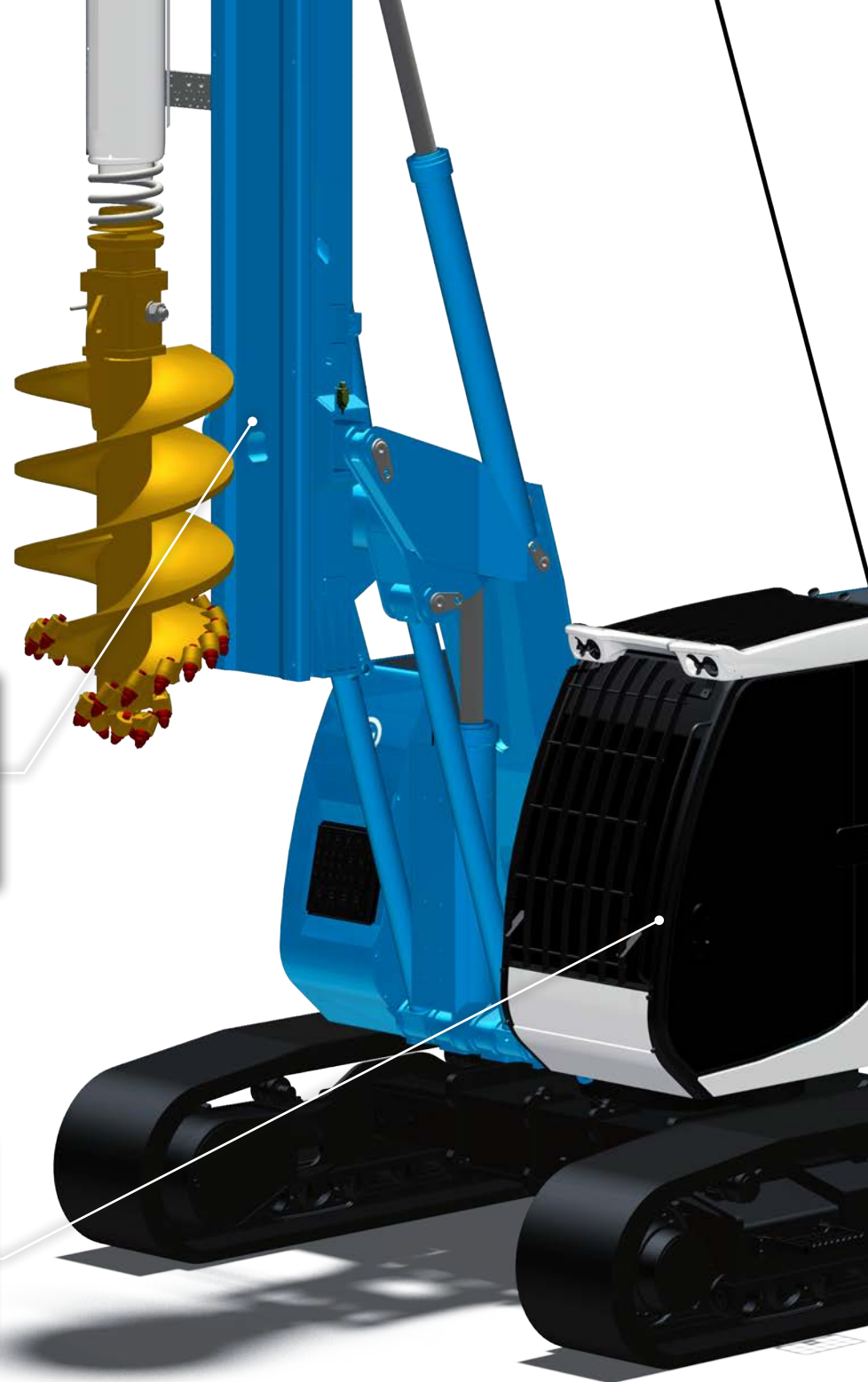

Higher performance

- Enhanced depth in CFA version
- Increased extraction force
- New segmental mast



More efficient

- Optimized lines to the rotary for cutting power loss
- Diesel engine – Auto low idle control for fuel saving
- Electric system SM 2.0



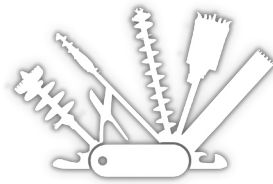
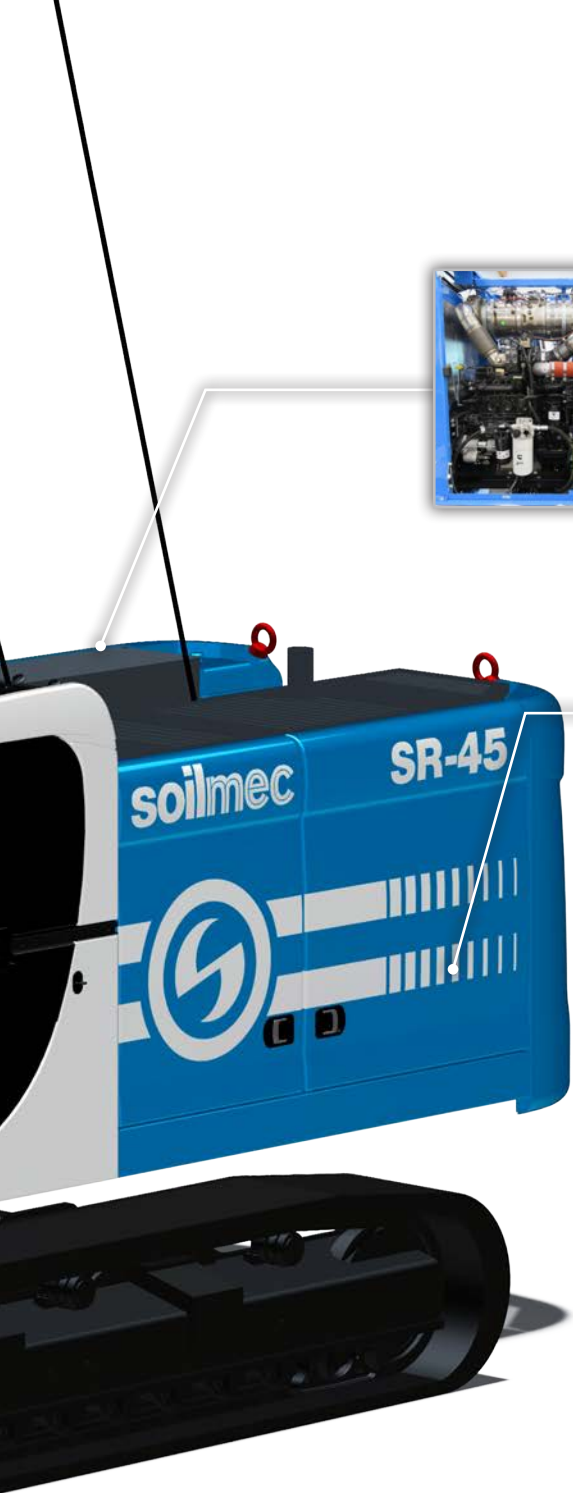

Truly multipurpose

- 5 technologies: LDP, CFA, DP/TCT, TJ and DTH
- Many versions: WCS, CCS, Segmental Mast, LHR, Quick Change, 4-lines pull



Environment-friendly

- Complies with the most stringent emission rules
- Lower CO2 emissions
- Noise reduction



Proven ergonomics

Sliding door, fully adjustable pneumatic suspension seat, joysticks and keyboards easy to use



Great visibility

Wide roof and front glass with protection grids, LED lights with anti-glare technology and CCTV camera system with dedicated 7" display



Most comfortable

Powerful HVAC system with recirculating air, USB port, locked glove boxes, a large compartment for placing helmet and jacket, cupholders and file folder



Always connected!

- DMS On Board 4.0
- DMS PC for a complete production analysis
- DMS Manager a cloud service for superior fleet supervision

SOILMEC TRACKS



Winch crowd system with an extraction force up to 240 kNm (53954 lbf) and up 15,95 m (52.3 ft) stroke to drive segmental casing of max. diameter 1200 mm (47 in).



The high strength steel segmental mast engineered for this unit is composed by two elements linked by a flange. Such a design allows to shorten or to extend the mast according to the job site needs without removing the section linked to parallelogram system. The solution enables to rapidly convert the rig machine in to the LHR configuration.

soilmecc

SR-45 ADV

Your safety is our priority

- Camera systems for 360° visibility, giving a clear surround view of the rig
- Powerful led lights
- Cab platform access with handrails
- Lowest noise emission
- Radio remote control for safer load/unload and tramming operations
- Automatic white sound alarm during rig travelling and turret rotation
- Warning system for sleeve extension coupling for CFA / DP / TJ technologies (patent pending).



SR-45 ADV

The answer to all your job site needs



- **Main winch rope anti-slack (Patent pending).** Managed by DMS, the system indicates when to slow down the kelly bar descent in order to avoid collision with the hole bottom and excessive rope unwinding for longer rope operation life
- **Automatic Mast Raising (Patented).** Automatic tensioning of main and service winch ropes during mast raising and boom adjustment to ease the operations during drilling/transport/maintenance phases
- **Automatic return to centre hole.** Designed to speed up the discharging phase. Very high slewing precision, for a perfect centering of the casing of the kelly bar. One word: faster cycle
- **Locking kelly bar visualization system (Patented).** Real time display of locking connection area to simplify the operator job and to protect the rig against wearing and tearing
- **CFA Autodrilling.** An automatic device for CFA mode to control and to optimize the drilling parameters
- **CFA Autorotary (Rotary Revolutions Speed Control).** The operator can activate this function by a dedicated pedal or through joystick
- **Easy maintenance,** automatic lubrication of all the necessary greasing points in kelly and CFA versions
- **Rotary cradle sliding guide replaceable w/o** dismantling the rotary
- **CFA/DP/TJ Sleeve extension connection visualization system (Patented).** Real time display correct connection between rotary and sleeve extension to simplify the operator job and to protect the rig against wearing and tearing.

SOILMEC



SR-45

soilmec



FAYMONVILLE

5

Warning

CAUTION
RIGGING TRAILER
BE WARE OF PIVOT POINT

www.FAYMONVILLE.COM



SR-45 ADV

Transport and start up never been so smart

Less than 30 minutes from truck to piling

Quick and efficient mobilization

Rapid start up on job site

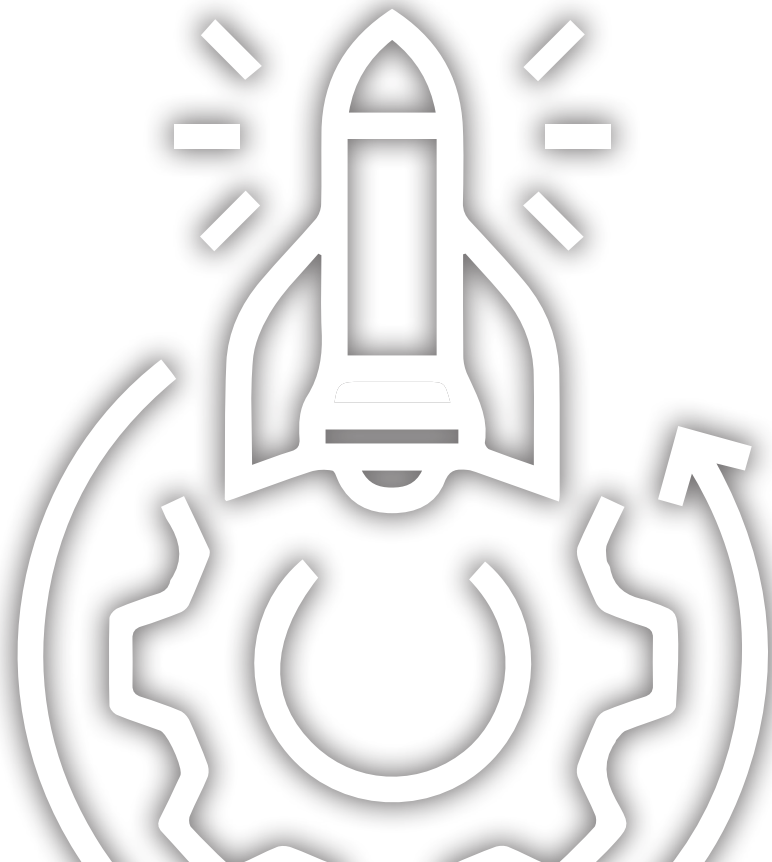

Transport

Large Diameter Piles

Cylinder Crowd System
Segmental mast

Winch Crowd System
Segmental mast

Cylinder Crowd System
Standard mast

Winch Crowd System
Upgraded - Standard mast

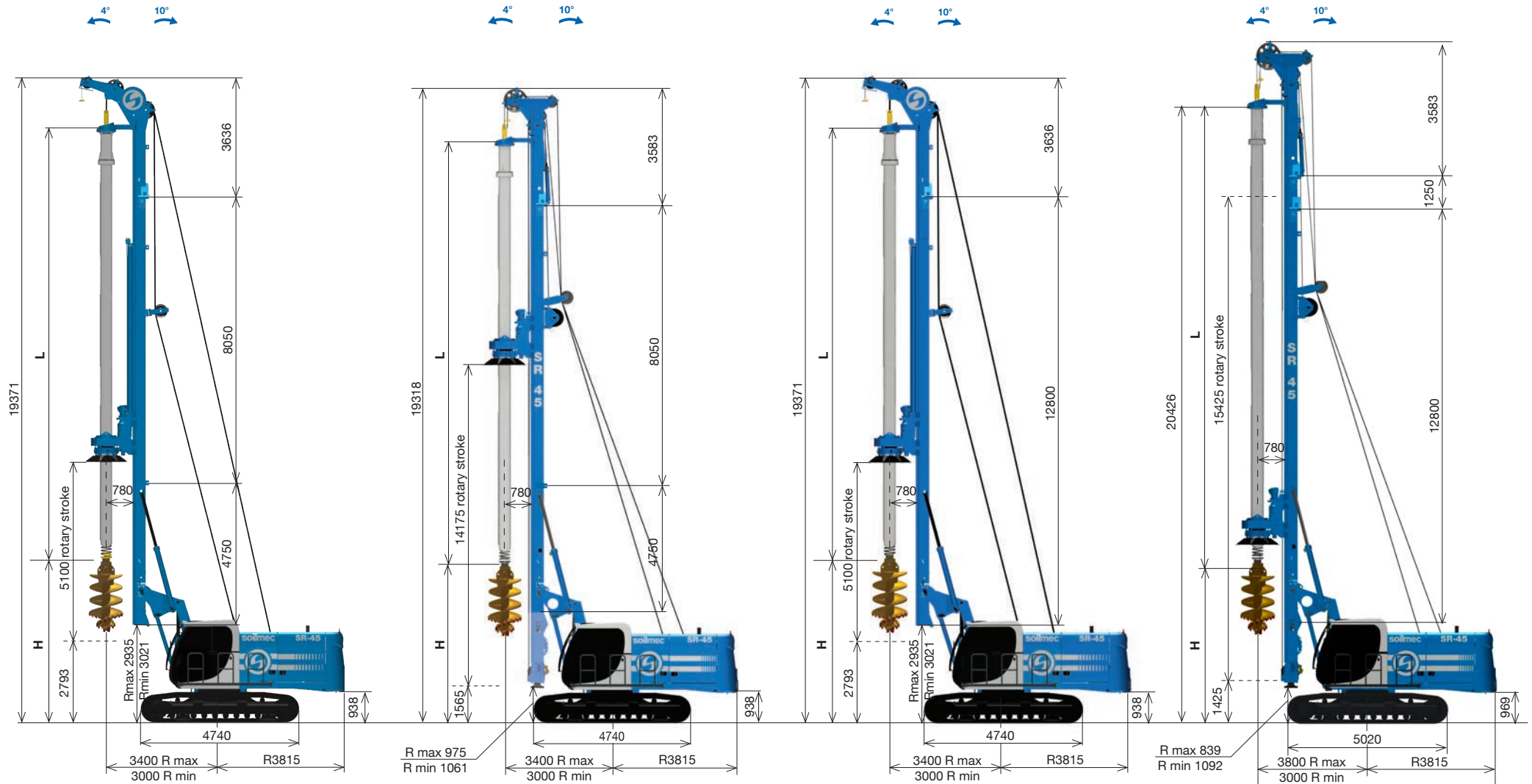

LDP - Large Diameter Piles - CCS version

Operating weight Tier 4f - w/o kelly bar ¹⁻²	37800 kg	83335 lb
Max pile diameter along mast	1500 mm	59 in
Max pile diameter w/o lower mast section, tool below mast	3000 mm	118 in
Working radius	3000 - 3400 mm	118 - 133 in
Tail swing radius	3815 mm	150 in
Max pile depth-friction kelly	59,4 (63,9) ² m	195 (210) ² ft
Max pile depth-locking kelly	47,4 (50,4) ² m	156 (165) ² ft

LDP - Large Diameter Piles - WCS version

Operating weight Tier 4f - w/o kelly bar ¹⁻³	39700 kg	87524 lb
Max pile diameter along mast	1400 mm	55 in
Max pile diameter w/o lower mast section, tool below mast	3000 mm	118 in
Working radius	3000 - 3400 mm	118 - 133 in
Tail swing radius	3815 mm	150 in
Max pile depth-friction kelly	65 m	213 ft
Max pile depth-locking kelly	51,7 m	170 ft

LDP - Large Diameter Piles - Upgraded version

Operating weight Tier 4f - w/o kelly bar - CCS version ¹⁻²	40100 kg	88405 lb
Operating weight Tier 4f w/o kelly bar - WCS version ¹⁻³	42000 kg	92594 lb
Working radius	3000 - 3800 mm	118 - 150 in
Max pile depth - CCS version	63,8 m	209 ft
Max pile depth - WCS version	69,7 m	229 ft

¹ For Stage V version. For Tier 3 version weight reduced by 300 kg (661 lb).

² For HD Monolithic mast standard version. Add 400 kg (882 lb) in segmental mast version.

³ For HD Monolithic mast standard version. Add 300 kg (661 lb) in segmental mast version.

⁴ Not self-mounting kelly bar.

Kelly bars for LDP

	Kelly type	Kelly dimens.	Drilling Depth ¹		Weight		L Length		H CCS system		H WCS system	
			m	ft	ton	US ton	m	ft	m	ft	m	ft
3 parts	BL HD	3 x 8	21,6	70.9	3,1	3.4	9,1	29.9	7,8	25.6	8,6	28.2
	BL HD	3 x 9	24,5	80.4	3,4	3.7	10,1	33.1	7,6	24.9	7,6	24.9
	BL HD	3 x 12	33,6	110.2	4,3	4.7	13,1	43.0	4,5	14.8	4,6	15.1
	BL HD ⁵	3 x 14	38,9	127.6	4,9	5.4	14,9	48.9	4,0 ³	13.1 ³	2,8	9.2
	BL HD	4 x 8	29,0	95.1	3,5	3.9	9,1	29.9	7,8	25.6	8,6	28.2
	BL HD	4 x 9	32,0	105.0	3,9	4.3	9,9	32.5	7,7	25.3	7,8	25.6
4 parts	BL HD	4 x 10,5	38,4	126.0	4,4	4.9	11,6	38.1	6,1	20.0	6,1	20.0
	BL HD	4 x 12	44,7	146.7	5,0	5.5	13,2	43.3	4,5	14.8	4,6	15.1
	BL HD	4 x 13	48,2	158.1	5,3	5.8	14,0	45.9	3,7	12.1	3,7	12.1
	BL HD	4 x 14	51,5	169.0	5,7	6.3	14,9	48.9	4,0 ³	13.1 ³	2,8	9.2
	FR HD	4 x 9	32,6	107.0	3,9	4.3	10,0	32.8	7,7	25.3	7,7	25.3
	FR HD	4 x 12	44,2	145.0	5,0	5.5	12,9	42.3	4,8	15.7	4,8	15.7
	FR HD	4 x 13	48,5	159.1	5,3	5.8	14,0	45.9	3,7	12.1	3,7	12.1
	FR HD ⁵	4 x 14	52,1	170.9	5,7	6.3	14,9	48.9	4,0 ³	13.1 ³	2,8	9.2
	FR HD	5 x 9	40,7	133.5	4,1	4.5	10,0	32.8	7,7	25.3	7,7	25.3
	FR HD ²	5 x 11	48,8	160.1	4,8	5.3	11,6	38.1	6,0	19.7	6,1	20.0
5 parts	FR HD	5 x 12	55,1	180.8	5,2	5.7	12,9	42.3	4,8	15.7	4,8	15.7
	FR HD	5 x 13	60,5	198.5	5,5	6.1	14,0	45.9	3,7	12.1	3,7	12.1
	FR HD ⁵⁻⁶	5 x 13,5	63,8	209.3	5,7	6.3	14,6	47.9	4,3 ³	14.1 ³	3,1	10.2
	FR HD ⁵⁻⁶	5 x 14	65,0	213.3	5,9	6.5	14,9	48.9	4,0 ³	13.1 ³	2,8	9.2
	FR HD ⁴⁻⁵⁻⁷	5 x 15	69,8	229.0	6,3	6.9	15,8	51.8	3,1 ³	10.2 ³	3,1 ³	10.2 ³

¹ Drilling depth is calculated with 1500 mm (4.9 ft) long, kelly bar c/w stub 150x150 or 130x130; Reduced drilling depth by 1100 mm (3.6 ft) in CCS version and in WCS version without lower mast section. Kelly bars are also available with stub 200x200 (depth, length and clearance are subjectd to changes).

² Rotary head derated

³ Clearance value with 1,25 m (4.1 ft) mast extension

⁴ Not self mounting without mast extension

⁵ Not self mounting in CCS version without mast extension

⁶ Could be necessary longer rope

⁷ Must be necessary longer rope

CFA / DP / TJ

4-lines pull
Special version
segmental mast

Quick change
Standard version

DP
Standard version

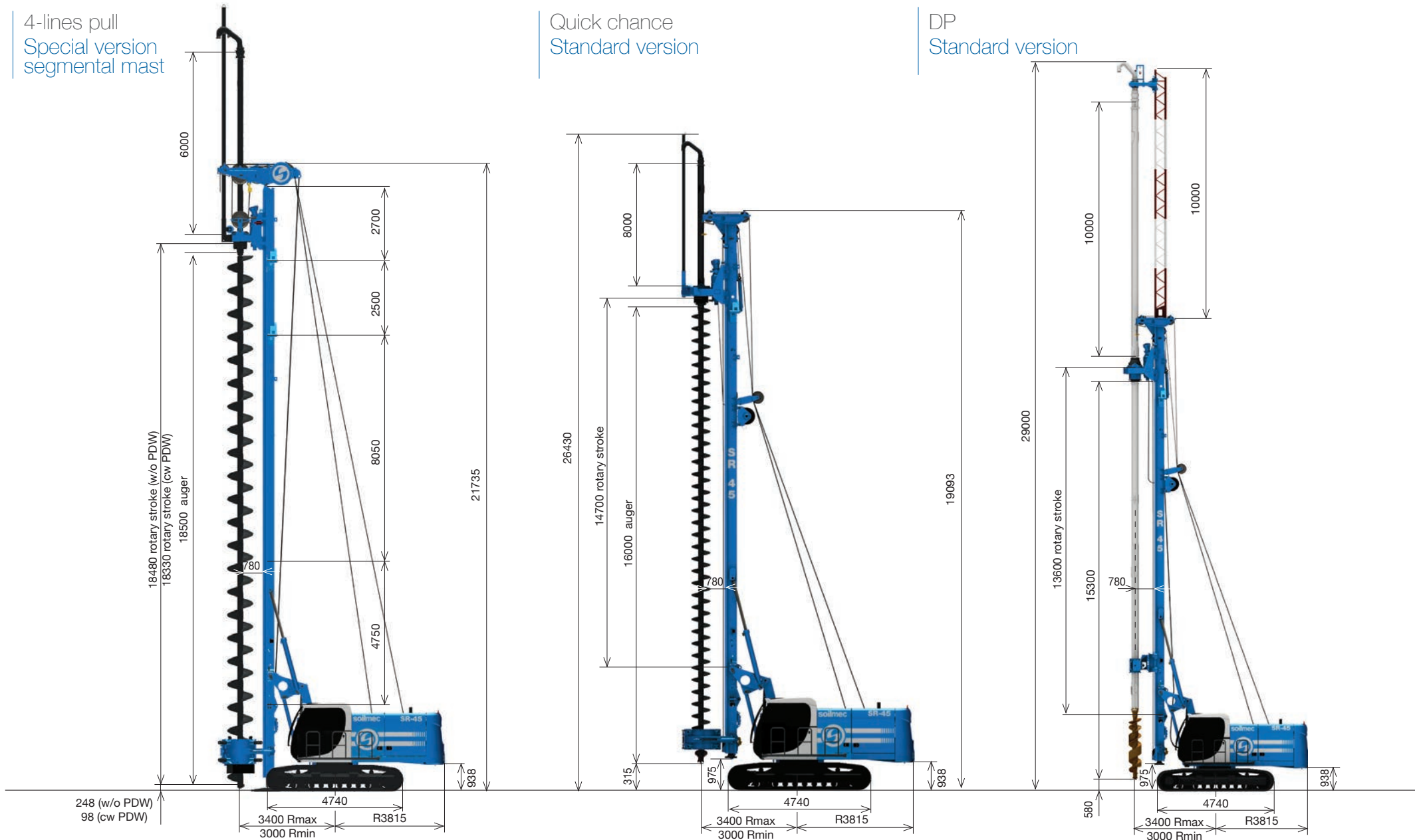

LHR

Low Head Room

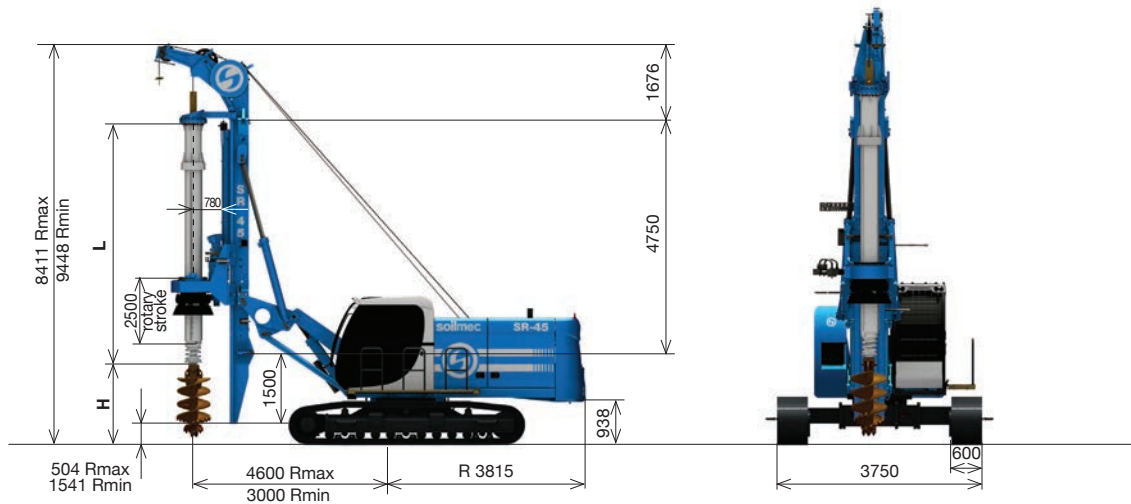

LHR - Low Head Room

Operating weight w/o kelly bar, cw add. counterweight	36700 kg	80910 lb
Min operating height	8,4 m	27.6 ft
Max operating height	9,45 m	31 ft
Max pile diameter	1500 mm	59 in
Max pile diameter w/o lower mast section, tool below mast	3000 mm	118 in
Max pile depth-friction kelly (c/w mast extension)	23,7 m	78 ft
Max pile depth-locking kelly (c/w mast extension)	19,3 m	63 ft
Cylinder crowd system stroke	2500 mm	98,43 in
Crowd force pull (down/up)	140 / 207 kN	31473 / 46535 lbf
Working radius	4600 - 3000 mm	181 - 118 in

Drawing are not to scale All technical data are purely indicative and subject to change without notice

Kelly bars for LHR

Standard version

H max 8,4 m / 27.6 ft - Max working radius

Kelly type	Kelly dims.	Weight		Drilling Depth		L Length		Clearance	
		ton	t(US)	m	ft	m	ft	m	ft
BL HD ¹	4 x 4,5	2,2	2.4	15,9	52.2	5,5	18.0	1,5	4.9
BL HD ²	4 x 5	2,4	2.6	16,5	54.1	5,8	18.9	1,2	3.9
BL HD ¹	5 x 4,5	2,4	2.6	19,4	63.6	5,5	18.0	1,5	4.9
BL HD ²	5 x 5	2,6	2.9	20,3	66.6	5,8	18.9	1,2	3.9

¹ Drilling depth with tool 1500 mm (4.9 ft) long

² Drilling depth with tool 1000 mm (3.3 ft) long

DTH



DTH - Down The Hole - Quick change		
Operating weight (w/o drill string and hammer)	41100 kg	90609 lb
Max pile diameter	800 mm	31,50 in
Max pile depth	14,3 m	46,92 ft
Rotary stroke	14,7 m	48,23 ft
Nominal extraction force	394 kN	88573 lbf
Additional crowd force on string	140 kN	31473 lbf

3 clamps optional kit		
Diameter range	60-415 mm	2,4-16,3 in
Max clamping force	266 kN	59800 lbf
Max breaking force	7900 daNm	58262 lbf

Rotary

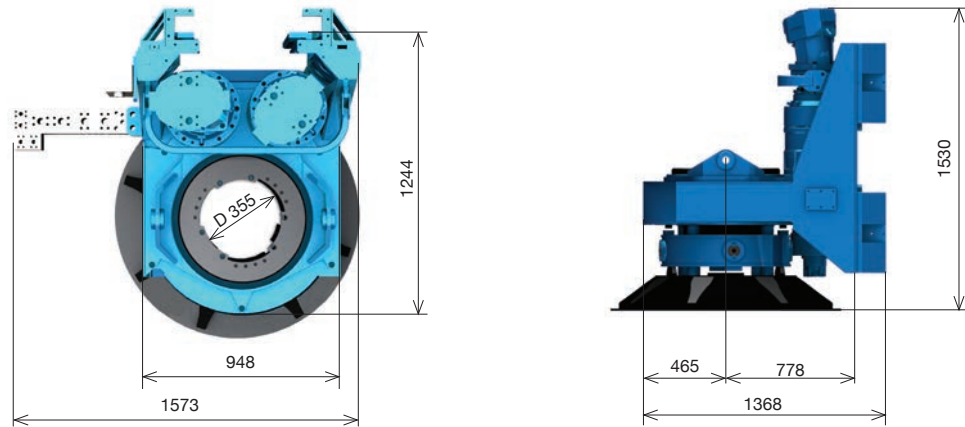

Rotary torque diagram

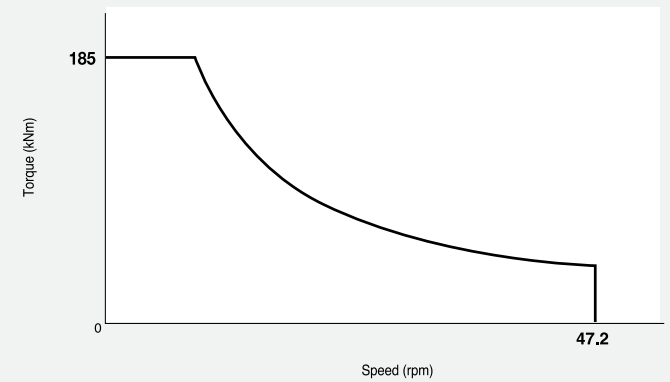

The easy replacement of the drive ribs and pads have been purposely designed for the specific needs of the job site.

Special rotary for using OD 394 mm (15.5 in) kelly bar is also available

Rotary drive	Spin off type	Spin off type
Max torque	185 kNm	136447 lbf*ft
Rated torque	161 kNm	118746 lbf*ft
Max drilling speed	47 rpm	47 rpm
Spin off speed	146 rpm	146 rpm
Weight (w/o cradle and casing flange)	2850 kg	6283 lb

Transport

Dimensions and Weights

Standard version

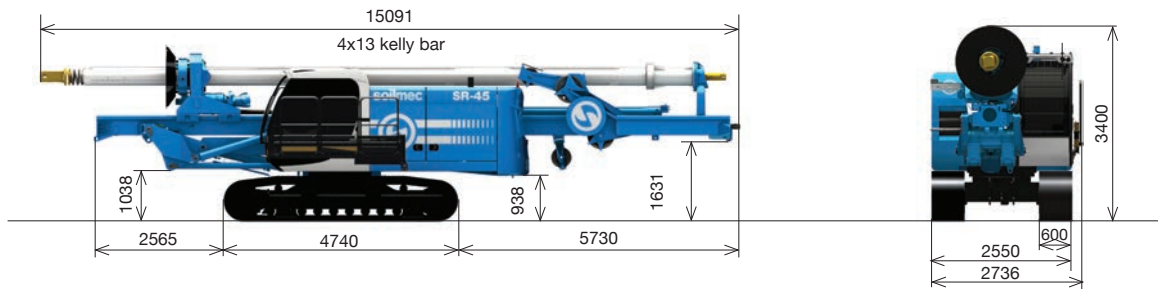

LHR version

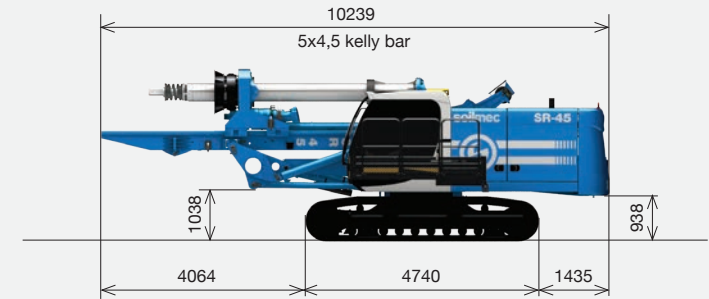

Transport standard version	CCS		WCS	
Transport weight ¹⁻²	41700 kg	91933 lb	43600 kg	96123 lb
Transport length ³	13050 mm	42.8 ft	13250 mm	43.5 ft

4-lines pull version

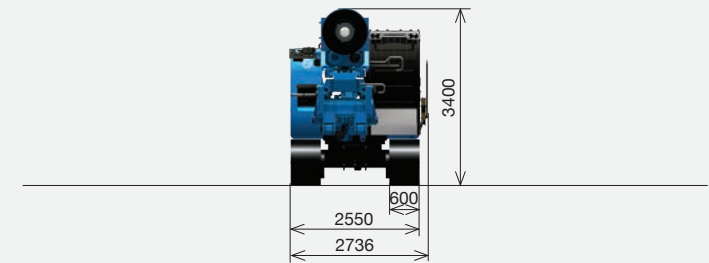
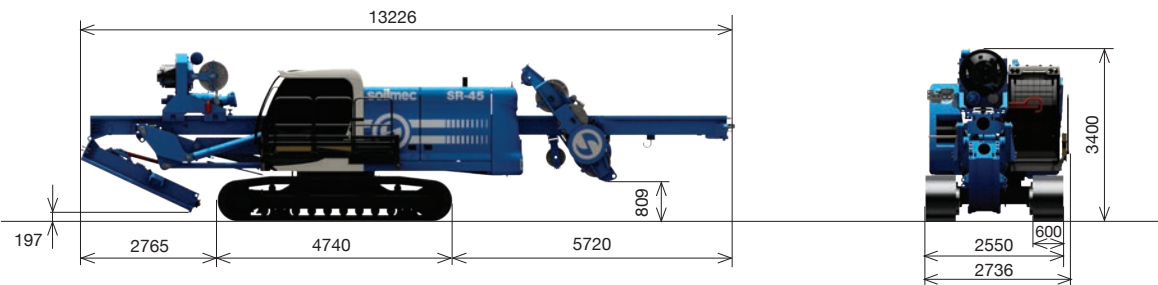

Transport CFA version	4-lines pull		Quick change	
Transport weight ¹	39300 kg	86642 lb	39300 kg	86642 lb
Transport length	13226 mm	43.4 ft	13250 mm	43.5 ft

Transport LHR version	8.5	
Transport weight ¹	39300 kg	86640 lb

¹ For HD Monolithic mast and Stage V version. For segmental mast version add 300 kg (661 lb) in WCS and Quick Change or add 400 kg (882 lb) in CCS and 4-lines pull; for Tier 3 version weight reduced by 300 kg (661 lb).

² c/w 4 x 9 m kelly bar.

³ c/w kelly bar < 12 m.

¹ c/w 5 x 4,5 m, kelly bar and additional counterweight

Technical data

Undercarriage

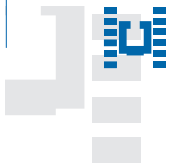

Especially designed for heavy duty applications that require less penetration, better turning capability and less ground disturbance. Maintenance-free crawler track. Hydraulic chain tensioning device.

Undercarriage		
- Type	variable gauge, telescoping sides frames	variable gauge, telescoping sides frames
- Overall width with retracted / extended crawlers ¹	2550 / 3750 mm	100 / 148 in
- Width of triple grouser track shoes ²	600 mm	24 in
- Overall length of crawlers	4740 mm	187 in
- Traction force	424 kN	95317 lbf
- Travelling speed	1,9 km/h	1.18 mph

¹ increased undercarriage is available on request, dimension 600 x 4000 x 5020 mm (24 x 157 x 198 in)

² 700 mm (27.5 in) and 800 mm (31.5 in) wide shoe available on request

Winches

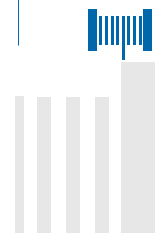

Main winch		
- Type	controlled descent	controlled descent
- Line pull (1st layer)	165 kN	37093 lbf
- Rope diameter	24 mm	740 in
- Line speed (max.)	78 m/min	256 ft/min

Auxiliary winch		
- Type	controlled descent	controlled descent
- Line pull (1st layer)	65 kN	14612 lbf
- Rope diameter	18 mm	740 in
- Line speed (max.)	81 m/min	266 ft/min

Noise



Noise		
- Sound pressure level in cab - Stage V	77 dB(A)	77 dB(A)
- Guaranteed sound power level (200/14/EC - Directive)	107 dB(A)	107 dB(A)
- Vibration transmitted to the hand-arm system of the machine operator	< 2.5 m/s	< 2.5 m/s
- Vibration transmitted to the whole body of the machine operator	< 0.5 m/s	< 0.5 m/s

Cab



By assessing the specific application and listening properly to the wishes and requirements of the operators, Soilmec provides the optimal operator cab for comfort. Ergonomic seat with air suspension, fully adjustable, lumbar support, air management, as well as lines of sight, quality and safety are standard aspects considered during the design of the right configuration for the cabin.

- Cabin width	1050 mm	3.4 ft
- Sliding door		
- Courtesy lights		
- Air conditioning system and climate control unit		
- Radio player with USB aux port		

Controls

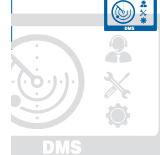

DMS control system, developed and manufactured by Soilmec - is designed to give you a total control over performance, production and all your drilling rigs. In real time all the information relating to the operation work cycles and diagnostics of faults are shown on a multi language touch screen display installed in the cab.

All drilling operations are actuated by two innovative joysticks.

Automatic controls of rotary head and drilling phases are available on request thanks to simple implementation of our DMS system.

Engine



Engine		
- Model	Cummins B6.7	Cummins B6 .7
- Rated output	209 kW @ 2000 rpm	280 HP @ 2000 rpm
- Engine conforms to Exhaust emission Standard	EU Stage V / US EPA Tier 4f	EU Stage V / US EPA Tier 4f
- Fuel tank capacity	380 l	100 US gal
- AD Blue tank capacity	57 l	15 US gal

¹ Cummins QSB 6.7 - US EPA Tier3 available on request

Hydraulic system



The cleaning of hydraulic oils is electronically monitored and any clogging is show to operator on DMS control system in the cab.

Main pumps flow		
- Main pump flow	2x 214 l/min	2x 57 US gal/min
- Auxiliary pump flow	160 l/min	42 US gal/min
- Hydraulic oil tank	450 l	119 US gal

CCS_Cylinder Crowd System		
- Stroke	5100 mm	201 in
- Crowd force pull (down/up)	140 / 207 kN	31473 / 46535 lbf
- Speed up	19 m/min	62 ft/min
- Speed down	25 m/min	82 ft/min

WCS_Winch Crowd System		
- Stroke ¹	14175 mm	740 in
- Crowd force pull (down/up)	240 / 240 kN	53953 / 53953 lbf
- Speed up	21,5 m/min	70.5 ft/min
- Speed down	21,5 m/min	70.5 ft/min

¹ c/w mast extension becomes 15425 mm (607 in)

Crowd system



Configurations

UNDERCARRIAGE

Variable gauge, telescopic side frames	●
Upgraded undercarriage	○
700 mm (27.5 in) wide shoe	○
800 mm (31.5 in) wide shoe	○
Machine anchor points for transport	●
Mechanical prearrangement for casing oscillator	●
Hydraulic prearrangement for casing oscillator	○
VRM120KL casing oscillator	○
Radio remote control for tramming operation	●

UPPER STRUCTURE

Diesel engine Cummins QSB 6.7	○
Diesel engine Cummins B 6.7 EU Stage V – US EPA Tier 4f	●
Start and slow system	●
Harness technology for electrical system	●
Automatic Greasing package	○
PTO kit for washing lancer	○
Prearrangement for Air compressor kit	○
Air compressor kit	○
Foldable side catwalks for cabin with hand rails	●
Machine lifting kit (harbor use)	○
Acoustic & light alarm for tramming	●
Lighting led system package	●
Sound proofed canopies	●
Front support for tools	○
Additional counterweight 1000 kg (2204 lb)	○

CAB

Front protective grille	●
Falling object protective structure (FOPS)	●
Rearview mirrors	●
Comfort package (cup holder, radio, A/C system, USB port & 12 V power socket, roll-up awning, courtesy lights)	●
Operator seat (air suspension, lumbar support, fully adjustable positioning, safety belt & operator presence micro-switch)	●
Lighting system in front of the cab	●

CONTROL AND MONITORING SYSTEM

DMS ON BOARD 4.0 with technological package	●
DMS PC	●
DMS manager 4.0	○
GSM / GPRS / WIFI Modem	●
DMS ON BOARD adjustable monitor 12" touch screen	●
Video control by 4 cameras with display in the cab	●

WINCHES

Main winch SW160 model	●
Load cell for main winch	○
Main & service winch pull instant value displayed on DMS On Board	○
Limit switch for rope winding and winches	●
Depthmeter for main winch	●
Anti-slack system for main winch	○
Service winch SW65 model	●
Load cell for service winch	●

ROTARY UNIT

Rotary unit c/w spin off - Max torque intermitted: 184.8 kNm (136301 lbs*ft)	●
Replaceable drive ribs	●
Quick disassembling rotary kit	○
Automatic greasing kit for cradle	●

MAST

Segmental mast	●
Monoolithic mast	○
Mast guide cleaner	●
Kit for assisted rasing mast (<i>patented</i>)	○
Lower foldable mast element	○
Hydraulic cathead folding kit	○
Cathead greasing kit	○
Double positioning of cylinder (<i>in LHR version</i>)	●

KELLY BAR TECHNOLOGY

Rotary sleeve with 3 ribs	●
Spin off discharging system	●
Cardan joint	○

Flange for casing driving d.1300 mm (51.1 in)	○
Flange for casing driving d.900 mm (34.4 in)	○
Automatic return to the centre hole	○
Kelly bar guide	●
Rotary with 6 ribs for OD 394mm (15,5 in) kelly	○

OTHER TECHNOLOGIES

HD-4 or HD-5 or 15-HD5 Sleeve 3 m (9.8 ft) long	○
HD-4 or HD-5 or 15-HD5 Sleeve 6 m (19.7 ft) long	●
HD-4 or HD-5 or 15-HD5 Sleeve 7 m (23 ft) long	○
HD-4 or HD-5 or 15-HD5 Sleeve 8 m (27.8 ft) long	○
Package for CFA quick change 16 m (52 ft) auger length	○
Package for CFA 4-lines pull 16 m (52 ft) auger length	○
Package for CFA 4-lines pull 18,5 m (61 ft) auger length	○
Package for CFA 4-lines pull 20,5 m (67,2 in) auger length	○
DMS ON BOARD with automatic auger lifting	○
Autodrilling package	○
Autorotary package	○
CFA 4-lines pull additional pull-down winch 100 kN (22481 lbf)	○
Hydraulic universal openable lower guide d.1000 mm (39.4 in)	○
Auger cleaner star type	○
Double roller auger cleaner d.1000 mm (39.4 in)	○
Two pressure transducers kit	○
WiFi sensore for concrete pressure	○
Warning system for CFA sleeve extension coupling (<i>patent pending</i>)	○
Hydraulic prearrangement for VTH-1 vibrator	○
Add. package for DP/TCT technology 23 m (75 ft) depth with lattice ext.	○
Add. package for TJ technology 23 m (75 ft) depth with lattice ext.	○
Package for DTH	○
3 clamps 60-415mm (2.4-16.3 in) for DTH version	○
4" swivel and bent curve	○
5" swivel and bent curve	●
Drilling energy measurement kit for displacement/CFA	○
Automatic greasing kit for concrete swivel	○
Concrete line for turret and mast	○

* The technology package is only referred to the machine set up in this specific version



www.soilmec.it

This brochure has been edited and distributed by SOILMEC Spa. The present document cancels and override any previous ones. This brochure shall not be distributed, reproduced or exhibited without SOILMEC Spa. authorization in accordance with to SOILMEC web site disclaimer condition.

SOILMEC Spa distributes machinery and structures all over the world, supported by SOILMEC Spa subsidiary companies and dealers. The complete Soilmec network list is available on the web site www.soilmec.it